



Listino prezzi 03/2019 Accessori ed attrezzature per la Refrigerazione

RIVACOLD
MASTERING COLD



Copeland



Embraco aspera

FASCOOLD



ELECTRICAL BOARDS
ELECTRICAL BOARDS FOR REFRIGERATING INSTALLATIONS



Viale Renato Serra, 14 - 20148 Milano
Tel. 02.36504891/2 - 02.33007466 - Fax 02.33005504
E-mail: info@deltateam-srl.it
Internet: www.deltateamsrl.it

INDICE ANALITICO

DESCRIZIONE	PAGINA	DESCRIZIONE	PAGINA
attrezzature per vuoto e carica	64-67	staffaggi	47-49
attrezzi e utensili	68-69	strumentazione ed attrezzature	61-66-71-73
capillari	46	temporizzatori meccanici	39
certificazioni di calibratura strumenti	63	termostati meccanici	39
componenti ed attrezzi per R744	60	tubi di rame	47-48
Compressori ermetici CUBIGEL	1	unità carenate silenziate	17-18
Compressori ermetici EMBRACO ASPERA	2-3	unità condensatrici ermetiche ad acqua	12
Compressori ermetici SECOP (Danfoss)	3	unità condensatrici ermetiche ad aria	10-11
Compressori ermetici TECUMSEH	6	unità semiermetiche ad acqua	12
Compressori ermetici/scroll MANEUROP	5	unità semiermetiche ad aria BITZER-RIVACOLD	14
Compressori Scroll DWM COMPELAND	5	unità semiermetiche ad aria FRASCOLD-LA BLU	15-16
Compressori semiermetici DORIN	9	unità semiermetiche ad aria FRASCOLD-RIVACOLD	13-14
Compressori semiermetici FRASCOLD	7-8	valvole a sfera	53
condensatori ad acqua	24	valvole pressostatiche per acqua	34
condensatori ad aria	26	valvole rotalock	53
documentazione tecnica	75	valvole solenoidi GMC-CASTEL	31
eliminatori di vibrazioni	33	valvole solenoidi per acqua	34
evaporatori statici	23-25	valvole termostatiche SPORLAN	40
evaporatori ventilati ECO	22	vaschette asciuga condensa	62
evaporatori ventilati RIVACOLD	19-21		
filtri disidratatori GMC	29-30-32		
filtri disidratatori per domestici	46		
gruppi manometrici digitali	73		
indicatori di liquido GMC	30		
isolanti	45-46		
lubrificanti	75		
minicelle frigorifere	27		
minipressostati	34		
monoblocchi RIVACOLD	28		
motoventilatori	42-44		
prodotti ALCO EMERSON	40-41		
prodotti chimici	73		
prodotti DANFOSS	35-37		
prodotti elettronici ELIWELL	56-57		
prodotti elettronici PEGO	56		
prodotti per la pulizia impianti	62		
prodotti RANCO	38-39		
quadri elettrici e prodotti PEGO	58-59		
raccorderia in ottone	50-51		
raccorderia in rame a saldare	54-55		
refrigeranti	74		
registratori grafici di temperatura	72-59		
resistenze elettriche (scarico e sbrinamento)	62		
ricevitori e separatori di liquido	33		
rubinetteria in ottone	52		
saldatura	70		
scambiatori a piastre	26		
separatori di olio	33		
silenziatori	33		

INDEX

DESCRIPTION	PAGE	DESCRIPTION	PAGE
air-cooled condensers	26	oil & liquid accumulators	33
ALCO biflux-driers	41	PEGO electrical boards & controls	56--58-59
ALCO electronic fan speed controller	41	R410 equipments	63
ALCO oil acid test kit	41	R744 equipments	60
ALCO thermostatic expansion valves	40	RANCO products	39
BITZER air condensing units	14	refrigerant recovery equipments	61
brass valves	53	refrigerants	74
brazing alloys, sealers and fluxes	70	RIVACOLD monoblocks	28
castel solenoid valves	31	RIVACOLD unit coolers	19-21
chemicals	73	SAGINOMIYA-DANFOSS water regulators	34
cleaning products	62	SPORLAN thermostatic expansion valves	40
compact cold rooms	27	technical books	75
copper solder fittings	54-55	TECUMSEH EUROPE hermetic compressors	06
copper tubes & capillary	47-48	thermometers	71-72
CUBIGEL hermetic compressors	1	thermostats	39
DANFOSS products	35-37	timers	40
data-loggers	59-72	tools	68-69
digital gauges and set	73	vacuum and charging equipments	64-67
domestic appliances copper driers	46	valve and fitting	53-56
DORIN semi-hermetic compressors	9	vibration eliminator	33
DWM COPELAND scroll compressors	5	water condensing units	12
ECO LUVATA unit coolers	22	welding racks	70
ELIWELL & PEGO products	56-59		
EMBRACO-ASPERA hermetic compressors	2-3		
flaring tools and tube cutters	68		
FRASCOLD semi-hermetic air condensing units	13-16		
FRASCOLD semi-hermetic compressors	7-8		
GMC products	29-32		
gravity coolers	23-25		
heat exchangers	26		
heaters & evaporating water trays	62		
hermetic air-condensing units	10-11		
housing air-condensing units	17-18		
Inch fittings	47		
inch shut-off valves	48		
insulating rolls & chemicals	45-46		
insulating tubes and plates	45-46		
intruments	61-76		
leak detectors	71		
leaks testing and pressure control	61		
liquid receivers	33		
lubricants	75		
MANEUROP compressors	5		
mini-pressure switch	34		
motor fans	42-44		
mufflers	33		
shut-off valves	53		

REFRIGERATION PRICE LIST MARCH 2019

COMPRESSORI ERMETICI CUBIGEL - R404A/R507 M/HBP
 CUBIGEL HERMETIC COMPRESSORS - R404A M/HBP



CODICE CODE	MODELLO MODEL	HP NOM.HP	CILINDR. DISPLACEM. cc	ESPANS. EXPANSION	RESA FRIG. * CAPACITY Watt	TENSIONE VOLTAGE	LISTINO PRICE LIST Euro
012420	ML40TB	1/6	4,04	C/N	308	220-240/1/50	180,40
012421	ML45TB	1/5	4,50	C/N	343	220-240/1/50	186,60
012422	ML60TB	1/4	5,67	C/N	407	220-240/1/50	190,70
012423	ML80TB	1/3	7,57	C/N	563	220-240/1/50	205,00
012424	ML90TB	3/8	8,85	C/N	674	220-240/1/50	215,30
012425	MPT12RA	1/2	12,00	C/N	929	220-240/1/50	289,70
012426	MPT14RA	1/2P	14,00	C/N	1.104	220-240/1/50	297,30
012428	MX18TB	3/4	18,37	C/N	1.347	220-240/1/50	408,00
012430	MX21TB	1	20,72	C/N	1.508	220-240/1/50	434,60
012431	MS26TB	1,2	25,93	C/N	1.950	220-240/1/50	510,50
012433	MS26T3	1,2	25,93	C/N	1.950	380-420/3/50	531,00
012432	MS34TB	1,5	34,42	C/N	2.740	220-240/1/50	533,00
012434	MS34T3	1,5	34,42	C/N	2.740	380-420/3/50	563,80

* RESA FRIGORIFERA / CAPACITY -10/+55°C

COMPRESSORI ERMETICI CUBIGEL - R404A/R507 M/LBP
 CUBIGELHERMETIC COMPRESSORS - R404A/R507 LBP

CODICE CODE	MODELLO MODEL	HP NOM.HP	CILINDR. DISPLACEM. cc	ESPANS. EXPANSION	RESA FRIG. * CAPACITY Watt	TENSIONE VOLTAGE	LISTINO PRICE LIST Euro
012400	ML45FB	1/6	4,60	C/N	134	220-240/1/50	186,60
012401	ML60FB	1/5	6,00	C/N	180	220-240/1/50	190,70
012402	ML80FB	1/4	8,10	C/N	256	220-240/1/50	205,00
012403	ML90FB	1/3	8,85	C/N	279	220-240/1/50	215,30
012512	MLY12LA	1/3P	12,00	C/N	339	220-240/1/50	256,30
012405	MP14FB	1/2	14,00	C/N	409	220-240/1/50	280,90
012407	MX18FB	5/8	18,37	C/N	491	220-240/1/50	373,10
012408	MX21FB	3/4	20,73	C/N	635	220-240/1/50	420,30
012409	MX23FB	7/8	23,20	C/N	732	220-240/1/50	451,00
012411	MS26FB	3/4	26,16	C/N	768	220-240/1/50	510,50
012412	MS34FB	1	34,42	C/N	1.026	220-240/1/50	533,00

* RESA FRIGORIFERA / CAPACITY -30/+55°C

COMPRESSORI ERMETICI CUBIGEL - R134A M/HBP
 CUBIGEL HERMETIC COMPRESSORS - R134a M/HBP

CODICE CODE	MODELLO MODEL	HP NOM.HP	CILINDR. DISPLACEM. cc	ESPANS. EXPANSION	RESA FRIG. * CAPACITY Watt	TENSIONE VOLTAGE	LISTINO PRICE LIST Euro
012500	B30G	1/12	3,10	C/N	117	220-240/1/50	129,20
012502	B35GL	1/10	3,50	C/N	130	220-240/1/50	133,30
012504	B38	1/8	3,80	C/N	160	220-240/1/50	137,40
012506	B43GL	1/6	4,30	C/N	168	220-240/1/50	139,40
012325	GL45TB	1/6	4,50	C/N	192	220-240/1/50	172,20
012330	GL60TB	1/5	5,67	C/N	244	220-240/1/50	182,50
012340	GL80TB	1/5	7,57	C/N	308	220-240/1/50	190,70
012345	GL90TB	1/4	8,85	C/N	372	220-240/1/50	198,90
012508	GLY12 RA	1/3	9,90	C/N	438	220-240/1/50	209,10
012355	GP14TB	3/8	14,00	C/N	546	220-240/1/50	235,80
012356	GP16TB	1/2	15,83	C/N	645	220-240/1/50	262,40
012360	GX18TB	1/2P	18,39	C/N	754	220-240/1/50	348,50
012363	GX21TB	5/8	20,72	C/N	792	220-240/1/50	395,50
012366	GX23TB	5/8P	23,20	C/N	887	220-240/1/50	408,00
012362	GS26TB	3/4	25,93	C/N	1.080	220-240/1/50	510,50
012365	GS34TB	1	34,42	C/N	1.580	220-240/1/50	533,00

* RESA FRIGORIFERA / CAPACITY -10/+55°C

COMPRESSORI ERMETICI EMBRACO - ASPERA - R404A/452A M/HBP

EMBRACO - ASPERA HERMETIC COMPRESSORS - R404A/452A M/HBP



CODICE CODE	MODELLO MODEL	HP NOM.HP	CILINDR. DISPLACEM. cc	ESPANS. EXPANSION	RESA FRIG. * CAPACITY Watt	TENSIONE VOLTAGE	LISTINO PRICE LIST Euro
010458	EMT6144GK	1/5	4,00	C/V	354	220-240/1/50	175,35
010456	EMT6152GK	1/5	4,50	C/V	396	220-240/1/50	184,80
010457	EMT6165GK	1/4	5,20	C/V	448	220-240/1/50	189,00
010445	NEK6181GK	1/3	7,28	C/V	565	220-240/1/50	199,50
010442	NEK6210GK	3/8	8,77	C/V	668	220-240/1/50	205,80
010438	NEK6213GK	1/2	12,11	C/V	917	220-240/1/50	220,50
010501	NEK6217GK	5/8P	14,30	C/V	959	220-240/1/50	305,55
010724	NEU6215GK	5/8	12,12	C/V	904	220-240/1/50	263,50
010615	NT6222GKACSR	3/4	17,40	C/V	1.040	220-240/1/50	411,60
010620	NT6224GKACSR	3/4P	20,40	C/V	1.532	220-240/1/50	427,35
010630	NT6226GKACSR	1	22,40	C/V	1.379	220-240/1/50	457,80
010433	NJ9226GK CSR	1	21,70	C/V	1.586	230/1/50	492,45
010449	NJ9226GS	1	21,70	C/V	1.586	380-420/3/50	530,25
010450	NJ9232GK CSR	1,2	26,14	C/V	1.895	230/1/50	497,70
010451	NJ9232GS	1,2	26,14	C/V	1.895	380-420/3/50	547,05
010452	NJ9238GK CSR	1,5	32,70	C/V	2.407	230/1/50	509,25
010453	NJ9238GS	1,5	32,70	C/V	2.419	380-420/3/50	557,55

* RESA FRIGORIFERA / CAPACITY -10/+55°C

COMPRESSORI ERMETICI EMBRACO - ASPERA - R404A/452A LBP

EMBRACO - ASPERA HERMETIC COMPRESSORS - R404A/452A LBP



CODICE CODE	MODELLO MODEL	HP NOM.HP	CILINDR. DISPLACEM. cc	ESPANS. EXPANSION	RESA FRIG. * CAPACITY Watt	TENSIONE VOLTAGE	LISTINO PRICE LIST
NC	EMT2117GK	1/4	4,50	C/V	171	220-240/1/50	210,00
NC	EMT2121GK	1/3	5,20	C/V	224	220-240/1/50	215,50
010402	EMT2125GK	1/3+	6,00	C/V	254	220-240/1/50	220,50
010407	NEK2134GK	1/2	8,77	C/V	327	220-240/1/50	233,10
010469	NEK2150GK	1/2P	12,10	C/V	405	220-240/1/50	273,00
010468	NEK2168GK	5/8L	14,30	C/V	448	220-240/1/50	333,90
010465	NT2178GK-CSR	3/4L	17,50	C/V	509	220-240/1/50	386,40
010466	NT2180GK-CSR	3/4	20,40	C/V	595	220-240/1/50	422,10
010435	NT2192GK-CSR	7/8	22,40	C/V	686	220-240/1/50	443,10
010467	NT2212GK-CSR	1,5	27,80	C/V	864	220-240/1/50	483,00
010726	NEU2140GK	1/2	8,78	C/V	326	220-240/1/50	299,00
010728	NEU2155GK	5/8L	12,12	C/V	432	220-240/1/50	331,00
010730	NEU2168GK	3/4	14,30	C/V	514	220-240/1/50	354,00
010732	NEU2168GJ-csr	3/4	14,30	C/V	514	220-240/1/50	405,00
010734	NEU2178GK-csr	7/8	16,80	C/V	586	220-240/1/50	416,50
010431	NJ2192GK CSR	1,2	26,00	C/V	754	220-240/1/50	468,30
010432	NJ2192GS	1,2	26,00	C/V	754	380-420/3/50	535,50
010436	NJ2212GK CSR	1,7	34,37	C/V	949	220-240/1/50	516,60
010437	NJ2212GS	1,7	34,37	C/V	949	380-420/3/50	569,10

* RESA FRIGORIFERA / CAPACITY -30/+55°C

COMPRESSORI ERMETICI EMBRACO - ASPERA - R134a M/HBP

EMBRACO - ASPERA HERMETIC COMPRESSORS - R134a M/HBP



CODICE CODE	MODELLO MODEL	HP NOM.HP	CILINDR. DISPLACEM. cc	ESPANS. EXPANSION	RESA FRIG. * CAPACITY Watt	TENSIONE VOLTAGE	LISTINO PRICE LIST Euro
010460	EMT6144Z	1/5	5,20	C/V	278	220-240/1/50	184,80
010461	EMT6160Z	1/4L	6,80	C/V	358	220-240/1/50	190,05
010462	EMT6170Z	1/4	7,70	C/V	398	220-240/1/50	200,55
010141	NEK6187Z	1/3	9,99	C/V	447	220-240/1/50	218,40
010143	NEK6210Z	3/8	12,11	C/V	535	220-240/1/50	227,85
010700	NEK6212Z	1/2L	14,30	C/V	405**	220-240/1/50	230,65
010705	NEK6214Z	1/2	16,80	C/V	824**	220-240/1/50	304,43
010736	NEU6210Z	3/8	12,12	C/V		220-240/1/50	287,00
010738	NEU6212Z	1/2L	14,30	C/V		220-240/1/50	303,00
010740	NEU6214Z	1/2	16,80	C/V		220-240/1/50	331,50
010742	NEU6214Z-csr	1/2	16,80	C/V		220-240/1/50	357,00
010715	NT6217Z	5/8L	20,40	C/V	1040**	220-240/1/50	357,73
010720	NT6220Z	3/4L	22,40	C/V	1104**	220-240/1/50	418,20
010160	NJ6220Z	3/4	25,80	C/V	1.054	220-240/1/50	476,70
010156	NJ6220ZX	3/4	25,80	C/V	1.109	380-420/3/50	535,50
010165	NJ6226Z	1	34,37	C/V	1.470	220-240/1/50	547,05
010161	NJ6226ZX-M	1	34,37	C/V	1.474	380-420/3/50	584,85

* RESA FRIGORIFERA / CAPACITY -10/+54,4°C

** RESA FRIGORIFERA / CAPACITY -10/+45°C

COMPRESSORI ERMETICI EMBRACO - ASPERA - R134a LBP

EMBRACO - ASPERA HERMETIC COMPRESSORS - R134a LBP

CODICE CODE	MODELLO MODEL	HP NOM.HP	CILINDR. DISPLACEM. cc	ESPANS. EXPANSION	RESA FRIG. * CAPACITY Watt	TENSIONE VOLTAGE	LISTINO PRICE LIST Euro
010200	EMT22HLP	1/12	3,00	C	156	220-240/1/50	162,75
010205	EMT36HLP	1/8	3,97	C	215	220-240/1/50	164,85
010210	EMT43HLP	1/8	4,85	C	262	220-240/1/50	173,25
NC	EMT49HLP	1/6	5,56	C	293	220-240/1/50	180,00
NC	NE2121Z	1/4	9,27	C/V	496	220-240/1/50	288,50
010230	NE2130Z	1/3	12,12	C/V	662	220-240/1/50	303,45

COMPRESSORI ERMETICI SECOP

SECOP HERMETIC COMPRESSORS - R404A

CODICE CODE	MODELLO MODEL	CILINDR. DISPLACEM. cc	ESPANS. EXPANSION	RESA FRIG. * CAPACITY Watt	TENSIONE VOLTAGE	LISTINO PRICE LIST Euro
011202	SC12CL-A-CSIR	12,90	C/V	1.220	220-240/1/50	370,30
011200	SC15CL-A-CSIR	15,30	C/V	1.407	220-240/1/50	378,90
011206	SC18CL-A-CSR	17,90	C/V	1.659	220-240/1/50	425,20
011204	SC21CL-A-CSR	20,95	C/V	1.659	220-240/1/50	453,20

* RESA FRIGORIFERA / CAPACITY -10/+54,4°C



COMPRESSORI SCROLL DWM COPELAND - R404A

DWM COPELAND SCROLL COMPRESSORS - R404A.



MODELLO MODEL	VOLUME SWEPT VOL. mc/h	TENSIONE VOLTAGE	HP NOM NOM. HP	RESA FRIG. W. CAPACITY Watt.		LISTINO PRICE LIST €uro
				-10°C tev	-30°C tev	
D-ZB15-KCE-TFD-551	5,9	400/3/50	2	3700	1380	1730,40
D-ZB19-KCE-TFD-551	6,80	400/3/50	2,5	4.600	1.980	1785,00
D-ZB21-KCE-TFD-551	8,60	400/3/50	3,0	5.500	2.380	1822,80
D-ZB26-KCE-TFD-551	10,00	400/3/50	4	6.350	2.800	2103,15
D-ZB30-KCE-TFD-551	11,80	400/3/50	4	7.550	3.250	2316,30
D-ZB38-KCE-TFD-551	14,50	400/3/50	5	9.400	4.050	2555,70
D-ZB45-KCE-TFD-551	17,00	400/3/50	6	10.950	4.750	2843,40
D-ZB50-KCE-TFD-551	19,80	400/3/50	7	13.050	2.800	3659,25
D-ZB58-KCE-TFD-551	22,10	400/3/50	8	14500	4.200	3948,00
D-ZB76-KCE-TFD-551	29,10	400/3/50	10	19.400	7.000	4835,25
D-ZB95-KCE-TFD-551	36,40	400/3/50	13	23.800	7.600	5406,45
D-ZB114-KCE-TFD-551	43,30	400/3/50	15	28300	8.500	5855,85

COMPRESSORI SCROLL DWM COPELAND - R407C A.C.

DWM COPELAND SCROLL COMPRESSORS - R407C A.C.

MODELLO MODEL	HP NOM NOM. HP	RESA FRIG. CAPACITY +7 / +50°C	TENSIONE VOLTAGE	ATTACCHI CONNECT. Saldare/solder	LISTINO PRICE LIST €uro
ZR28-K3E-PFJ-522	2,5	6.400	220-240/1/50	3/4" x 1/2"	1.567,00
ZR28-K3E-TFD-522	2,5	6.400	400/3/50 460/3/60	3/4" x 1/2"	1.624,00
ZR34-K3E-PFJ-522	2,75	7.600	220-240/1/50	3/4" x 1/2"	1.640,00
ZR34-K3E-TFD-522	2,75	7.600	400/3/50 460/3/60	3/4" x 1/2"	1.702,00
ZR40-K3E-PFJ-522	3,5	8.900	220-240/1/50	3/4" x 1/2"	1.755,00
ZR40-K3E-TFD-522	3,5	8.900	400/3/50 460/3/60	3/4" x 1/2"	1.827,00
ZR48-KCE-TFD-522	4	11.000	400/3/50 460/3/60	7/8" x 1/2"	2.011,00
ZR61-KCE-TFD-522	5	13.500	400/3/50 460/3/60	7/8" x 1/2"	2.259,00
ZR72-KCE-TFD-522	6	15.900	400/3/50 460/3/60	7/8" x 1/2"	2.715,00
ZR81-KCE-TFD-522	6,75	18.100	400/3/50 460/3/60	7/8" x 3/4"	2.865,00
ZR90-K3E-TWD961	7,5	20.300	400/3/50 460/3/60	1"3/8" x 7/8"	5.013,00
ZR94-KCE-TFD455	7,5	19.000	400/3/50 460/3/60	1"3/8" x 7/8"	3.734,00
ZR108-KCE-TFD455	9	21.000	400/3/50 460/3/60	1"3/8" x 7/8"	4.634,00
ZR125-KCE-TFD455	10	25.000	400/3/50 460/3/60	1"3/8" x 7/8"	5.120,00
ZR144-KCE-TFD455	10	29.000	400/3/50 460/3/60	1"3/8" x 7/8"	5.418,00

ACCESSORI PER COMPRESSORI COPELAND / COPELAND COMPRESSOR ACCESSORIES

CODICE CODE	MODELLO MODEL	DESCRIZIONE DESCRIPTION	LISTINO PRICE LIST €uro
901065	1-3/4UNF35	Rubinetto di aspirazione / Suction valve ZR90/11/12/16	68,80
901010	1-1/4UNF22	Rubinetto di mandata / Discharge valve ZR90/11/12/16	43,40
901028	2-1/4UNF42	Rubinetto di aspirazione / Suction valve ZR19	131,60
901030	1-3/4UNF28	Rubinetto di mandata / Discharge valve ZR19	67,60
scroll control		relais rel 7231 - controllo sequenza trifase - (anti inversione) / control relais rel 7231	126,80



COMPRESSORI ERMETICI MANEUROP - SERIE /MTZ

MANEUROP HERMETIC COMPRESSORS - MTZ SERIES

CODICE CODE	MODELLO MODEL	HP NOM.HP	CILINDR. DISPLAC. mc/h	RESA FRIG. CAPACITY WATT		TENSIONE VOLTAGE	LISTINO PRICE LIST €uro
				R404A/R507 -25/+50°C	R134a -10/+50°C		
011001	MTZ18JA4	1,50	5,26	610	1.010	400/3/50 440/3/60	1034,50
011008	MTZ22JC4	1,80	6,58	980	1.335	400/3/50 440/3/60	1098,10
011015	MTZ28JE4	2,30	8,29	1.325	1.750	400/3/50 440/3/60	1143,70
011022	MTZ32JF4	2,70	9,30	1.490	2.000	400/3/50 440/3/60	1145,80
011029	MTZ36JG4	3,00	10,60	1.900	2.760	400/3/50 440/3/60	1205,20
011036	MTZ40JH4	3,50	12,00	1.970	3.220	400/3/50 440/3/60	1240,30
011043	MTZ44HJ4	3,75	13,20	1.980	2.860	400/3/50 440/3/60	1456,70
011050	MTZ50HK4	4,00	14,80	2.425	3.320	400/3/50 440/3/60	1562,80
011057	MTZ56HL4	4,60	16,72	2.520	3.720	400/3/50 440/3/60	1572,30
011064	MTZ64HM4	5,00	18,60	3.170	4.220	400/3/50 440/3/60	1644,50
011071	MTZ72HN4	6,00	20,92	3.700	5.000	400/3/50 440/3/60	1933,00
011078	MTZ80HP4	6,50	23,70	4.170	6.000	400/3/50 440/3/60	2313,90
011085	MTZ100HS4	8,50	29,80	4.800	6.480	400/3/50 440/3/60	3219,90
011092	MTZ125HU4	10,00	37,60	6.620	8.050	400/3/50 440/3/60	3793,80
011106	MTZ160HW4	13,00	47,25	8.900	11.780	400/3/50 440/3/60	4279,30

DISPONIBILI SU RICHIESTA TENSIONI DIVERSE / AVAILABLE ON REQUEST DIFFERENT VOLTAGES

COMPRESSORI SCROLL MANEUROP - SERIE SZ

MANEUROP SCROLL COMPRESSORS - SZ SERIES

CODICE CODE	MODELLO MODEL	HP NOM.HP	RESA FRIG. CAPACITY WATT		TENSIONE VOLTAGE	LISTINO PRICE LIST €uro
			R407C +5/+54°C	R134a +5/+54°C		
N.C.	SZ084-4VI	6,5	20000	14110	380/3/50 460/3/60	**
N.C.	SZ090-4VI	7,5	21450	15130	380/3/50 460/3/60	**
N.C.	SZ100-4VI	8,50	23320	16450	380/3/50 460/3/60	**
N.C.	SZ110-4VI	9,00	24830	17255	380/3/50 460/3/60	**
N.C.	SZ115-4RI	9,00	25975	18050	380/3/50 460/3/60	**
N.C.	SZ120-4VI	10,00	26810	18835	380/3/50 460/3/60	**
N.C.	SZ125-4RI	10,00	27930	19620	380/3/50 460/3/60	**
N.C.	SZ160-4RI	13,00	36060	25415	380/3/50 460/3/60	**
N.C.	SZ175-4RI	14,00	38770	27795	380/3/50 460/3/60	**
N.C.	SZ185-4RI	15,00	41690	29385	380/3/50 460/3/60	**
N.C.	SZ240-A4MBI	20,00	49295	**	380/3/50 460/3/60	**
N.C.	SZ300-A4MBI	25,00	60639	**		**

QUOTAZIONI SU RICHIESTA / PRICE AVAILABLE ON REQUEST

ACCESSORI PER COMPRESSORI MANEUROP / MANEUROP COMPRESSOR ACCESSORIES

CODICE CODE	MODELLO MODEL	DESCRIZIONE DESCRIPTION	LISTINO PRICE LIST €uro
901000	1"UNF-12	Rubinetto di mandata / Discharge valve MT/MTZ18-40	23,80
901005	1.1/4"UNF-18	Rubinetto di mandata / Discharge valve MT/MTZ44-80	30,20
901010	1.1/4"UNF-22	Rubinetto di mandata / Discharge valve MT/MTZ100-160	43,40
901000	1"UNF-12	Rubinetto di aspirazione / Suction valve MT/MTZ18-28	23,80
901020	1.1/4"UNF-16	Rubinetto di aspirazione / Suction valve MT/MTZ32-40	30,20
901025	1.3/4"UNF-22	Rubinetto di aspirazione / Suction valve MT/MTZ44-72	48,20
901030	1.3/4"UNF-28	Rubinetto di aspirazione / Suction valve MT/MTZ80-160	67,60
011002	PTC30W	Riscaldatore olio carter / Crankcase oil heater	48,90



COMPRESSORI ERMETICI TECUMSEH EUROPE - R404A M-HBP
 TECUNSEH L'UNITE' HERMETIQUE HERMETIC COMPRESSORS - R404A M-HBP

CODICE CODE	MODELLO MODEL	HP NOM.HP	CILINDR. DISPLAC.	ESP. EXP.	RESA FRIG. * CAPACITY WATT		TENSIONE VOLTAGE	LISTINO PRICE LIST
			cc		(1)	(2)		€uro
N.C.	AE4460Z (cae9460z)	1/2	10,30	C/V	1.122	688	220-240/1/50	373,80
N.C.	AE4470Z (cae9470z)	1/2P	12,00	C/V	1.508	976	220-240/1/50	381,15
N.C.	CAJ9480Z	5/8	15,20	C/V	1.599	976	220-240/1/50	605,85
N.C.	TAJ9480Z	5/8	15,20	C/V	1.599	976	400/3/50 440/3/60	576,45
N.C.	CAJ9510Z	3/4	18,30	C/V	1.941	1.198	220-240/1/50	635,25
N.C.	TAJ9510Z	3/4	18,30	C/V	1.941	1.198	400/3/50 440/3/60	615,30
N.C.	CAJ9513Z	1,1	24,20	C/V	2.426	1.419	220-240/1/50	667,80
N.C.	TAJ9513Z	1,1	24,20	C/V	2.425	1.419	400/3/50 440/3/60	646,80
N.C.	CAJ4517Z	1,2	25,90	C/V	2.729	1.664	220-240/1/50	687,75
N.C.	TAJ4517Z	1,2	25,90	C/V	2.729	1.664	400/3/50 440/3/60	667,80
N.C.	CAJ4519Z	1,5	34,40	C/V	3.603	2.237	220-240/1/50	730,80
N.C.	TAJ4519Z	1,5	34,40	C/V	3.603	2.237	400/3/50 440/3/60	709,80
N.C.	TFH4524Z	2	43,50	C/V	5.364	2.479	400/3/50 440/3/60	846,30
N.C.	TFH4531Z	2,5	56,60	C/V	3.358	5.677	400/3/50 440/3/60	877,80
N.C.	TFH4540Z	3	74,20	C/V	4.475	7.276	400/3/50 440/3/60	919,80

* RESA FRIGORIFERA / CAPACITY (1) 0/+54,4°C - (2) -10/+54,4°C

COMPRESSORI ERMETICI TECUMSEH EUROPE - R404A M-LBP
 TECUNSEH L'UNITE' HERMETIQUE HERMETIC COMPRESSORS - R404A M-LBP

CODICE CODE	MODELLO MODEL	HP NOM.HP	CILINDR. DISPLAC.	ESP. EXP.	RESA FRIG. * CAPACITY WATT		TENSIONE VOLTAGE	LISTINO PRICE LIST
			cc		(1)	(2)		€uro
<i>attacchi a saldare / solder connect.</i>								
013150	CAJ2428Z	5/8	15,20	C/V	1.301	354	220-240/1/50	454,30
013152	TAJ2428Z	5/8	15,20	C/V	1.301	354	400/3/50 440/3/60	550,20
013154	CAJ2432Z	3/4	18,30	C/V	1.593	502	220-240/1/50	555,80
013156	CAJ2446Z	1,2	26,15	C/V	2.150	708	220-240/1/50	605,30
013158	TAJ2446Z	1,2	26,15	C/V	2.150	708	400/3/50 440/3/60	618,60
013160	CAJ2464Z	1,7	34,45	C/V	3.055	973	220-240/1/50	625,20
013162	TAJ2464Z	1,7	34,45	C/V	3.055	973	400/3/50 440/3/60	735,40
013164	FH2480Z	2	53,20	C/V	4.419	1.319	220-240/1/50	974,70
013166	TFH2480Z	2	53,20	C/V	4.419	1.319	400/3/50 440/3/60	939,40
013168	FH2511Z	3	74,20	C/V	6.222	2.016	220-240/1/50	1003,30
013170	TFH2511Z	3	74,20	C/V	6.222	2.016	400/3/50 440/3/60	968,00

* RESA FRIGORIFERA / CAPACITY (1) -10/+54,4°C - (2) -30/+54,4°C



COMPRESSORI SEMIERMETICI FRASCOLD

FRASCOLD SEMI-HERMETIC COMPRESSORS

CODICE CODE	MODELLO MODEL	HP NOM. HP	CILINDR. DISPLACEM. mc/h	CAR.OLIO OIL CHARGE Lt.	RESA FRIG. CAPACITY WATT		LISTINO PRICE LIST Euro
					-10/+50°C R404A/R507	-30/+50°C R404A/R507	
020000	A 0.5 4 Y	0,50	3,95	1,2	1.770	630	1477,00
020002	A 0.5 5 Y	0,50	4,93	1,2	2.140	770	1477,00
020004	A 0.7 5 Y	0,75	4,93	1,2	2.140	770	1491,50
020006	A 0.7 6 Y	0,75	5,47	1,2	2.350	850	1491,50
020008	A 1 6 Y	1,00	5,47	1,2	2.410	860	1504,90
020010	A 1 7 Y	1,00	6,91	1,2	2.970	1.070	1507,90
020012	A 1.5 7 Y	1,50	6,91	1,2	3.080	1.090	1538,10
020014	A 1.5 8 Y	1,50	7,65	1,2	3.400	1.190	1559,80
020016	B 1.5 9.1 Y	1,50	8,96	1,2	3.930	1.420	1559,80
020018	B 1.5 10.1 Y	1,50	9,84	1,2	4.540	1.700	1559,80
020020	B 2 10.1 Y	2,00	9,84	1,2	4.460	1.630	1689,20
020022	D 2 11.1 Y	2,00	11,26	1,2	4.930	1.790	1964,50
020024	D 2 13.1 Y	2,00	13,84	1,2	5.910	2.210	1964,50
020026	D 3 13.1 Y	3,00	13,84	1,2	5.980	2.180	2073,20
020028	D 2 15.1 Y	2,00	15,36	1,2	-	2.640	1964,50
020030	D 3 15.1 Y	3,00	15,36	1,2	6.640	2.520	2073,20
020032	D 3 16.1 Y	3,00	16,39	1,2	7.260	2.900	2073,20
020034	D 4 16.1 Y	4,00	16,39	1,2	7.430	2.950	2093,90
020038	D 3 18.1 Y	3,00	17,93	1,2	7.890	3.170	2093,90
020040	D 4 18.1 Y	4,00	17,93	1,2	8.050	3.210	2433,30
020042	D 3 19.1 Y	3,00	19,12	1,2	8.460	3.600	2125,90
020047	Q 4 21.1 Y	4,00	20,71	1,8	9.960	4.060	2787,30
020049	Q 5 21.1 Y	5,00	20,71	1,8	9.900	3.960	3079,20
020051	Q 4 24.1 Y	4,00	24,69	1,8	-	4.180	2855,60
020053	Q 5 24.1 Y	5,00	24,69	1,8	11.540	4.790	3272,70
020054	Q 7 25 Y	7,50	24,69	1,8	11.750	4.870	3415,50
020056	Q 5 28.1 Y	5,00	27,88	1,8	13.070	5.480	3343,10
020058	Q 7 28.1 Y	7,50	27,88	1,8	12.940	4.670	3343,10
020059	Q 5 33.1 Y	5,00	32,66	1,8	-	5.810	3551,10
020060	S 5 33 Y	5,50	32,80	3,3	-	6.130	3949,60
020061	Q 7 33 Y	7,50	32,66	1,8	14.880	5.880	3685,70
020062	S 7 33 Y	7,50	32,80	3,3	15.080	5.670	4104,90
020064	S 8 42 Y	7,50	38,25	3,3	18.050	7.370	4104,90
020066	S 12 42 Y	10,00	38,25	3,3	18.080	7.190	4273,60
020068	S 10 52 Y	10,00	50,43	3,3	-	9.390	4411,20
020070	S 15 52 Y	15,00	50,43	3,3	23.070	8.830	4673,10
020072	S 15 56 Y	15,00	56,00	3,3	26.420	10.290	4985,00
020074	S 20 56 Y	20,00	56,00	3,3	26.470	10.330	5270,30

TENSIONE STANDARD / STANDARD VOLTAGE 230/3/50 400/3/50 DOL (serie/range A-B-C-D-F-Q)

TENSIONE STANDARD / STANDARD VOLTAGE 400/3/50 PWS (serie/range S)



FRASCOLD



COMPRESSORI SEMIERMETICI FRASCOLD
FRASCOLD SEMI-HERMETIC COMPRESSORS

CODICE CODE	MODELLO MODEL	HP NOM. HP	CILINDR. DISPLACEM. mc/h	CAR.OLIO OIL CHARGE Lt.	RESA FRIG. CAPACITY WATT		LISTINO PRICE LIST Euro
					-10/+50°C R404A/R507	-30/+50°C R404A/R507	
020076	V 15 59 Y	15,00	58,48	4,5	27.380	10.770	5989,60
020078	V 20 59 Y	20,00	58,48	4,5	27.360	10.350	6111,70
020080	V 15 71 Y	15,00	70,77	4,5	-	12.680	6111,70
020082	V 25 71 Y	25,00	70,77	4,5	32.390	12.240	6362,20
020084	V 20 84 Y	20,00	83,81	4,5	31.830	12.020	6362,20
020086	V 30 84 Y	30,00	83,81	4,5	39.130	15.230	6611,50
020087	V 25 93 Y	25,00	93,05	4,5	35.390	13.290	6611,50
020089	V 32 93 Y	32,00	93,05	4,5	35.130	-	6864,20
020088	Z 25 106 Y	25,00	106,16	4,5	-	19.010	8239,70
020090	Z 35 106 Y	35,00	106,16	4,5	49.340	18.290	5239,70
020092	Z 30 126 Y	30,00	125,72	7,5	-	22.960	8541,90
020094	Z 40 126 Y	40,00	125,72	7,5	57.570	22.040	8917,60
020096	W 40 142 Y	40,00	141,50	8,0	67.550	25.340	12185,10
020098	Z 40 154 Y	40,00	154,38	7,5	71.110	28.200	9806,70
020100	Z 50 154 Y	50,00	154,38	7,5	70.470	26.800	10031,30
020102	W 40 168 Y	40,00	167,60	8,0	-	31.970	12185,10
020104	W 50 168 Y	50,00	167,60	8,0	80.310	30.270	12432,50
020106	W 50 187 Y	50,00	186,10	8,0	-	35.380	12432,50
020108	W 60 187 Y	60,00	186,10	8,0	89.170	33.190	12934,40
020110	W 60 206 Y	60,00	205,80	8,0	100.170	39.200	12934,40
020112	W 70 206 Y	70,00	205,80	8,0	98.860	37.430	13687,90
020113	W 70 228 Y	70,00	227,77	8,0	109.010	41.360	13687,90
020111	W 75 228 Y	75,00	227,77	8,0	109.590	-	14440,40
020115	W 75 240 Y	75,00	239,02	8,0	114.620	43.410	15090,30
020114	W 80 240 Y	80,00	205,80	8,0	114.770	-	15090,30

TENSIONE STANDARD / STANDARD VOLTAGE 400/3/50 PWS

ACCESSORI PER COMPRESSORI FRASCOLD / FRASCOLD COMPRESSOR ACCESSORIES

020116	T00CH13	RISCALDATORE OLIO CARTER / CRANCKCASE OIL HEATER 50W	A-B-C-D	139,80
020118	T00CH1	RISCALDATORE OLIO CARTER / CRANCKCASE OIL HEATER 70W	F-Q-S	139,80
020119	T00CH9	RISCALDATORE OLIO CARTER / CRANCKCASE OIL HEATER 150W	V-Z-W	203,90



FRASCOLD



COMPRESSORI SEMIERMETICI DORIN M-HBP

DORIN M-HBP SEMI-HERMETIC COMPRESSORS

CODICE CODE	MODELLO MODEL	CILINDR. DISPLACEM. mc/h	CAMPO RANGE	RESA FRIG. CAPACITY WATT -10/+45°C R404A	LISTINO PRICE LIST Euro	
N.C.	H80CC	729	4,42	M-HBP	2050	1659,70
N.C.	H101CC	733,00	5,37	M-HBP	2660	1669,20
N.C.	H151CC	741,00	6,71	M-HBP	3190	1687,10
N.C.	H181CC	751,00	7,50	M-HBP	3580	1710,40
N.C.	H201CC	788,00	9,16	M-HBP	4400	1794,80
N.C.	H221CC	813,00	9,88	M-HBP	4750	1851,80
N.C.	H251CC	813,00	10,61	M-HBP	5120	1851,80
N.C.	H281CC	849,00	11,64	M-HBP	5700	1933,10
N.C.	H300CC	981,00	15,94	M-HBP	7140	2234,00
N.C.	H350CC	981,00	15,94	M-HBP	7800	2234,00
N.C.	H380CC	1143,00	17,53	M-HBP	8640	2602,50
N.C.	H403CC	1461,00	19,98	M-HBP	9260	3326,70
N.C.	H503CC	1482,00	22,83	M-HBP	11400	3374,20
N.C.	H743CC	1645,00	26,44	M-HBP	13470	3745,90
N.C.	H751CC	1762,00	31,88	M-HBP	15340	4011,90
N.C.	H1002CC	1784,00	38,06	M-HBP	18310	4061,50
N.C.	H1201CC	1982,00	42,81	M-HBP	21880	4512,30
N.C.	H1501CC	2093,00	48,82	M-HBP	24910	4765,70

COMPRESSORI SEMIERMETICI DORIN M-LBP

DORIN M-LBP SEMI-HERMETIC COMPRESSORS

CODICE CODE	MODELLO MODEL	CILINDR. DISPLACEM. mc/h	CAMPO RANGE	RESA FRIG. CAPACITY WATT -30/+45°C R404A	LISTINO PRICE LIST Euro	
N.C.	H51CS	722,00	4,42	M-LBP	**	1643,90
N.C.	H80CS	729,00	5,37	M-LBP	1030	1659,70
N.C.	H101CS	733	6,71	M-LBP	1230	1669,20
N.C.	H151CS	741	7,50	M-LBP	1420	1687,10
N.C.	H181CS	751	9,16	M-LBP	1720	1710,40
N.C.	H201CS	788	9,88	M-LBP	1860	1794,80
N.C.	H221CS	813	10,61	M-LBP	2000	1851,80
N.C.	H251CS	849	11,64	M-LBP	2240	1933,10
N.C.	H281CS	882	13,23	M-LBP	2400	2008,10
N.C.	H290CS	956	14,74	M-LBP	2770	2177,00
N.C.	H300CS	981	15,94	M-LBP	3060	2234,00
N.C.	H390CS	1143	19,53	M-LBP	4000	2602,50
N.C.	H392CS	1187	23,31	M-LBP	4530	2702,80
N.C.	H403CS	1461	22,83	M-LBP	4340	3326,70
N.C.	H503CS	1552	26,44	M-LBP	5430	3533,60
N.C.	H751CS	1762	38,06	M-LBP	7030	4011,90
N.C.	H350SB	981	17,53	LBP	3470	2234,00
N.C.	H380SB	1010	19,53	LBP	3980	2299,50



UNITA' CONDENSATRICI ERMETICHE AD ARIA

AIR-COOLED HERMETIC CONDENSING UNITS



UNITA' CONDENSATRICI ERM. CON COMPRESSORE ASPERA - R404A/452A-M/HBP

AIR-COOLED HERMETIC COND. UNITS - ASPERA COMPRESSOR EQUIPPED R404A/452A-M/HBP

CODICE CODE	MODELLO MODEL	HP NOM.	COMPR. COMPR.	EXP. EXP.	RESA FRIG. *		TENSIONE VOLTAGE	LISTINO PRICE LIST
					-10°C	0°C		
030250	ACU20KSHC	1/5	EMT6144GK	C	381	520	220-240/1/50	416,20
030101	ACU22KSHC	1/5P	EMT6152GK	C	422	573	220-240/1/50	426,50
030251	ACU25KSHC	1/4	EMT6165GK	C	492	672	220-240/1/50	438,80
030252	ACU34KSHC	1/3	NEK6181GK	C	608	838	220-240/1/50	465,60
030253	ACU38KSHC	3/8	NEK6210GK	C	721	978	220-240/1/50	479,00
030254	ACU50KSHC **	1/2	NEK6213GK	C	934	1.251	220-240/1/50	499,00
030497	ACU56NUSHC	1/2P	NEU6215GK	C	1.062	1.423	220-240/1/50	532,00
030255	ACU20KSH	1/5	EMT6144GK	V	381	520	220-240/1/50	432,60
030113	ACU22SH	1/5P	EMT6152GK	V	422	573	220-240/1/50	443,00
030256	ACU25KSH	1/4	EMT6165GK	V	492	672	220-240/1/50	461,50
030257	ACU34KSH	1/3	NEK6181GK	V	608	838	220-240/1/50	493,40
030258	ACU38KSH	3/8	NEK6210GK	V	721	978	220-240/1/50	497,50
030259	ACU50KSH **	1/2	NEK6213GK	v	934	1.251	220-240/1/50	534,60
030496	N-ACU67NU SH	1/2P	NEU6215GK	V	1.062	1.423	220-240/1/50	599,00
030470	N-ACU80NTSH	3/4	NT6222GK	V	1.289	1.782	220-240/1/50	773,60
030465	N-ACU88NTSH	3/4P	NT6224GK	V	1.570	2.142	220-240/1/50	788,00
030455	N-ACU105NTSH	1,00	NT6226GK	V	1.728	2.348	220-240/1/50	852,90
030460	N-ACU105NTSH2V	1,00	NT6226GK	V	1.740	2.370	220-240/1/50	1.012,50
030137	N-ACU100SH2V	1,00	NJ9226GK	V			220-240/1/50	1.041,00
030139	ACU100SHT-2V	1	NJ9226GS	V	1.625	2.248	380/3/BF	1.063,00
030141	ACU120SH-2V	1,2	NJ9232GK	V	1.915	2.636	220-240/1/50	1.170,00
030143	ACU120SHT-2V	1,2	NJ9232GS	V	1.915	2.636	380/3/BF	1.161,90
030149	ACU150SH-2V	1,5	NJ9238GK	V	2.681	3.702	220-240/1/50	1.262,00
030147	ACU150SHT-2V	1,5	NJ9238GS	V	2.681	3.702	380/3/BF	1.295,00

UNITA' CONDENSATRICI ERMETICHE AD ARIA CON COMPRESSORE ASPERA - R134a-M/HBP

AIR-COOLED HERMETIC CONDENSING UNITS - ASPERA COMPRESSOR EQUIPPED R134a-M/HBP

030260	ACU20KNHC	1/5	EMT6160Z	C	378	540	220-240/1/50	432,60
030261	ACU25KNHC	1/4	EMT6170Z	C	425	612	220-240/1/50	437,80
030262	ACU33KNHC	1/3	NEK6187Z	C	499	739	220-240/1/50	543,90
030263	ACU38KNHC	3/8	NEK6210Z	C	599	875	220-240/1/50	550,10
030450	N-ACU48KNHC	1/2'L	NEK6212Z	C	669	963	220-240/1/50	588,20
030495	N-ACU52KNHC	1/2	NEK6214Z	C	750	1.083	220-240/1/50	651,00
030264	ACU20KNH	1/5	EMT6160Z	V	378	540	220-240/1/50	437,80
030265	ACU25KNH	1/4	EMT6170Z	V	425	612	220-240/1/50	485,20
030266	ACU33KNH	1/3	NEK6187Z	V	521	817	220-240/1/50	555,20
030267	ACU38KNH	3/8	NEK6210Z	V	632	984	220-240/1/50	571,70
030500	N-ACU48KNH	3/8	NEK6212Z	V	669	963	220-240/1/50	653,00
030505	N-ACU52KNH	1/2	NEK6214Z	V	750	1.083	220-240/1/50	672,60
030506	N-ACU54NTNH	1/2P	NT6215Z	V	799	1.147	220-240/1/50	715,90
030510	N-ACU56NTNH	5/8L	NT6217Z	V	922	1.331	220-240/1/50	768,40
030515	N-ACU68NTNH	3/4L	NT6220Z	V	1.010	1.432	220-240/1/50	799,30
030180	ACU75NH	3/4	NJ6220Z	V	1.126	1.729	220-240/1/50	913,00
030182	ACU75NHT	3/4	NJ6220ZX	V	1.126	1.729	380/3/BF	896,10
030184	ACU100NH	1	NJ6226Z	V	1.494	2.050	220-240/1/50	928,10
030186	ACU100NH-2V	1	NJ6226Z	V	1.494	2.050	220-240/1/50	1.004,30
030188	ACU101NHT	1	NJ6226ZX	V	1.494	2.050	380/3/BF	991,90
030189	ACU101NHT-2V	1	NJ6226ZX	V	1.494	2.050	380/3/BF	1.087,70

* RESA FRIGORIFERA / CAPACITY TEMP. AMBIENTE / AMBIENT TEMP. +32°C

**= modello in esaurimento / end of series model

UNITA' CONDENSATRICI ERMETICHE AD ARIA

AIR-COOLED HERMETIC CONDENSING UNITS



UNITA' CONDENSATRICI ERMETICHE CON COMPRESSORE ASPERA - R404A/452A - LBP

AIR-COOLED HERMETIC CONDENSING UNITS - ASPERA COMPRESSOR EQUIPPED R404A-LBP

CODICE CODE	MODELLO MODEL	HP NOM.	COMPR. COMPR.	EXP. EXP.	RESA FRIG. *		TENSIONE VOLTAGE	LISTINO PRICE LIST
					-10°C	-30C		
030268	ACU20KSL	1/4	EMT2121GK	V	**	200	220-240/1/50	512,00
030269	ACU33KSL	1/3	EMT2125GK	V	**	239	220-240/1/50	565,50
030270	ACU34KSL	3/8	NEK2130GK	V	600	305	220-240/1/50	533,60
030271	ACU38KSL	1/2L	NEK2134GK	V	695	353	220-240/1/50	560,40
030400	N-ACU50KSL	1/2	NEK2150GK	V	**	405	220-240/1/50	607,70
030402	N-ACU55NTSL	1/2P	NT2168GK	V	**	414	220-240/1/50	727,50
030404	N-ACU58KSL	5/8L	NEK2168GK	V	**	448	220-240/1/50	638,60
030406	N-ACU70NTSL	3/4L	NT2178GK	V	**	509	220-240/1/50	719,00
030408	N-ACU74NTSL	3/4	NT2180GK	V	**	595	220-240/1/50	758,10
030410	N-ACU95NTSL	7/8	NT2192GK	V	**	686	220-240/1/50	856,00
030202	ACU120SL	1,2	J2192GK	V	**	696	220-240/1/50	995,90
030412	N-ACU150NTSL	1,50	NT2212GK	V	**	864	220-240/1/50	911,60
030206	ACU170SL	1,7	J2212GK	V	**	975	220-240/1/50	1.073,50
030208	ACU170SLT	1,7	J2212GS	V	**	952	380/3/BF	1.189,00

UNITA' CONDENSATRICI ERMETICHE AD ARIA CON COMPRESSORE L'UNITE' HERMETIQUE-R404A/452A

AIR-COOLED HERMETIC CONDENSING UNITS - L'UNITE' HERMETIQUE COMPRESSOR EQUIPPED R404A

M/HBP

CODICE CODE	MODELLO MODEL	HP NOM.	COMPR. COMPR.	campo range	RESA FRIG. *		TENSIONE VOLTAGE	LISTINO PRICE LIST
					-10°C	0°C		
030338	HCU200SH-2V	2	FH4524Z	M-HBP	2.750	4.615	220-240/1/50	2.013,70
030340	HCU200SHT-2V	2	TFH4524Z	M-HBP	2.754	4.619	400/3/50	1.982,00
030342	HCU250SH-2V	2,5	FH4531Z	M-HBP	3.728	6.144	220-240/1/50	2.380,00
030344	HCU250SHT-2V	2,5	TFH4531Z	M-HBP	3.728	6.144	400/3/50	2.063,00
030346	HCU300SHT-2V	3	TFH4540Z	M-HBP	4.864	7.676	400/3/50	2.497,00

M/LBP

CODICE CODE	MODELLO MODEL	HP NOM.	COMPR. COMPR.	campo range	RESA FRIG. *		TENSIONE VOLTAGE	LISTINO PRICE LIST
					-10°C	-30C		
030350	HCU120SLT	1,2	TAJ2446Z	M-LBP	**	753	400/3/50	1.103,00
030352	HCU170SLT	1,5	TAJ2464Z	M-LBP	**	981	400/3/50	1.322,00
030332	HCU200SLT-2V	2	TFH2480Z	M-LBP	5.190	1.745	400/3/50	1.995,00
030336	HCU250SLT-2V	2,5	TFH2511Z	M-LBP	6.900	2.628	400/3/50	2.023,50



UNITA' CONDENSATRICI ERMETICHE AD ACQUA

WATER-COOLED HERMETIC CONDENSING UNITS

UNITA' CONDENSATRICI ERMETICHE AD ACQUA CON COMPRESSORE ASPERA - R404A/452A - M/HBP

WATER-COOLED HERMETIC CONDENSING UNITS - ASPERA COMPRESSOR EQUIPPED R404A-M/HBP



COMPLETE DI PRESSOSTATO DI ALTA E VALVOLA REGOLATRICE AUTOMATICA DELL'ACQUA

WITH HIGH PRESSURE SWITCH AND WATER VALVE REGULATOR MOUNTED

CODICE CODE	MODELLO MODEL	HP NOM. HP	COMPR. COMPR.	EXP. EXP.	RESA FRIG. * CAPACITY WATT		TENSIONE VOLTAGE	LISTINO PRICE LIST €uro
					-10°C	0°C		
030229	ACU20SHW	1/5	EMT6144GK	V	441	641	220-240/1/50	820,00
030230	ACU22SHW	1/5	EMT6152GK	V	493	715	220-240/1/50	830,00
030232	ACU25SHW	1/4	EMT6165GK	V	569	824	220-240/1/50	861,00
030234	ACU34SHW	1/3	NEK6181GK	V	702	1.041	220-240/1/50	870,00
030236	ACU38SHW	3/8	NEK6210GK	V	859	1.240	220-240/1/50	925,00
030238	ACU50SHW	1/2	NEK6213GK	V	1.141	1.654	220-240/1/50	973,50
030241	N-ACU71KSHW	5/8	NEK6217GK	V	1.347	1.958	220-240/1/50	1.060,00
030243	N-ACU80TSHW	3/4	NT6222GK	V	1.627	2.403	220-240/1/50	1.181,50
030244	ACU100SHW	1	J9226GK	V	2.113	3.260	220-240/1/50	1.277,00

* RESA FRIGORIFERA / CAPACITY TEMP. AMBIENTE / AMBIENT TEMP. +32°C

UNITA' CONDENSATRICI SEMI- ERMETICHE AD ACQUA FRASCOLD

WATER-COOLED SEMI-HERMETIC FRASCOLD CONDENSING UNITS

CODICE CODE	MODELLO MODEL	HP NOM. HP	COMPR. COMPR.	CAMPO RANGE R404A	RESA FRIG. * CAPACITY WATT		TENSIONE VOLTAGE	LISTINO PRICE LIST €uro
					-10°C R404A	0°C R404A		
NC	WCU054	0,5	A05-4Y	M-HBP	1980	2930	400/3/50	3.823,00
NC	WCU075	0,75	A07-5Y	M-HBP	2440	3600	400/3/50	3.878,00
NC	WCU106	1	A1-6Y	M-HBP	2700	3990	400/3/50	3.897,00
NC	WCU157	1,5	B1,5-7Y	M-HBP	3420	5050	400/3/50	4.006,00
NC	WCU211	2	D2-11Y	M-HBP	5580	8230	400/3/50	4.733,00
NC	WCU313	3	D3-13Y	M-HBP	7270	10630	400/3/50	4.989,00
NC	WCU315	3	D3-15Y	M-HBP	7490	10950	400/3/50	4.989,00

CODICE CODE	MODELLO MODEL	HP NOM. HP	COMPR. COMPR.	CAMPO RANGE R404A	RESA FRIG. * CAPACITY WATT		TENSIONE VOLTAGE	LISTINO PRICE LIST €uro
					-30°C R404A	-20°C R404A		
NC	WCU055	0,5	A05-5Y	M-LBP	910	1560	400/3/50	3.823,00
NC	WCU076	0,75	A07-6Y	M-LBP	1010	1730	400/3/50	3.878,00
NC	WCU107	1	A1-7Y	M-LBP	1270	2180	400/3/50	3.897,00
NC	WCU159	1,5	B1,5-9Y	M-LBP	1850	3100	400/3/50	4.078,00
NC	WCU213	2	D2-13Y	M-LBP	2610	4720	400/3/50	4.733,00
NC	WCU215	2	D2-15Y	M-LBP	3300	5310	400/3/50	4.733,00
NC	WCU318	3	D3-18Y	M-LBP	3680	5940	400/3/50	5.025,00

LE UNITA' SONO EQUIPAGGIATE CON CONDENSATORE A PIASTRA-RICEVITORE ERMETICO VERTICALE, VALVOLA REGOLATRICE AUTOMATICA DELL'ACQUA-FILTRO DEIDRATATORE-SOLENOIDE-INDICATORE LIQUIDO-PRESSOSTATO DOPPIO RUBINETTO LINEA LIQUIDO E ANTIVIBRANTE ASPIRAZIONE

WATER CONDENSING UNITS ARE SUPPLIED WITH: FILTER DRIER, MOIST. INDICATOR, SOLENOID VALVE, DUAL PRESSURE SWITCH, WATER REGULATING VALVE, SUCTION VIBRATION ELIMINATOR

UNITA' CONDENSATRICI SEMIERMETICHE AD ARIA -R404A/R448A/R449A/R452A
R404A/R448A/R449A/R452A SEMI-HERMETIC CONDENSING UNITS

UNITA' CONDENSATRICI SEMIERMETICHE AD ARIA 2 VENTILATORI CON COMPRESSORE FRASCOLD **
*AIR-COOLED SEMIHERMETIC CONDENSING UNITS WITH 2 FAN MOTORS - FRASCOLD COMPRESSOR EQUIPPED ***

CODICE CODE	MODELLO MODEL	HP NOM. HP	VENT. FANS	COMPR. COMPRES. TYPE	W.RESI W.OUTPUT	DIMENSIONI DIMENSIONS LxPxH	LISTINO PRICE LIST Euro
R404A MHPB - Voltaggio standard / Standard voltage 400/3/50					-10te/+32°Cta		
021470	P-FH004Z2012-ACC	0,5	2X300	A 0.5 4 Y	2.104	800x560x415	2.600,00
021516	P-FH005Z2012-ACC	0,75	2X300	A 0.7 5 Y	2.545	800x560x415	2.661,00
021471	P-FH006Z2012-ACC	1	2X300	A 1 6 Y	2.867	800x560x415	2.712,50
021472	P-FH007Z2012-ACC	1,5	2X350	A 1.5 7 Y	3.651	930x680x456	3.014,10
021473	P-FH008Z2012-ACC	1,5	2X350	A 1.5 8 Y	4.066	930x680x456	3.090,70
021474	P-FH009Z2012-ACC	1,5	2X350	B 1.5 9 Y	4.539	930x680x456	3.164,10
021475	P-FH010Z2012-ACC	2	2X350	B 2 10 Y	4.930	930x680x456	3.371,90
021476	P-FH011Z2012-ACC	2	2X350	D 2 11 Y	5.684	930x680x456	3.462,50
021477	P-FH013Z2012-ACC	3	2X350	D 3 13 Y	6.768	930x680x606	3.773,50
021478	P-FH015Z2012-ACC	3	2X400	D 3 15 Y	7.790	1.110x785x626	4.007,90
021479	P-FH016Z2012-ACC	4	2X400	D 4 16 Y	8.635	1.110x785x626	4.379,70
021480	P-FH018Z2012-ACC	4	2X400	D 4 18 Y	9.169	1.110x785x626	4.596,90
021481	P-FH021Z2012-ACC	5	2X450	Q 5 21 Y	10.658	1.110x785x726	5.489,10
021482	P-FH025Z2012-ACC	7	2X450	Q 7 25 Y	13.568	1.300x870x851	6.011,00
021483	P-FH033Z2012-ACC	7	2X450	Q 7 33 Y	16.403	1.300x870x851	6.681,30
021540	P-FH042Z2012-ACC	12	2X560	S 12 42 Y	20.594	1650X1050X876	8.428,20
021485	P-FH051Z2012-ACC	15	2X630	S 15 51 Y	25.540	2.180x1.250x1.208	9.400,00
R404A LBP - Voltaggio standard / Standard voltage 400/3/50					-30te/+32°Cta		
021500	P-FL005Z2012-ACC	0,5	2X300	A 0.5 5 Y	975	800x560x415	2.661,00
021501	P-FL007Z2012-ACC	1	2X300	A 1 7 Y	1.355	800x560x415	2.765,70
021520	P-FL009Z2012-ACC	1	2X300	B 1.5 9 Y	1.707	800x560x415	2.967,20
021502	P-FL010Z2012-ACC	1,5	2X300	B 1.5 10 Y	1.861	800x560x415	2.987,50
021503	P-FL013Z2012-ACC	2	2X350	D 2 13 Y	2.795	930x680x456	3.526,60
021504	P-FL015Z2012-ACC	2	2X350	D 2 15 Y	2.981	930x680x456	3.600,00
021505	P-FL016Z2012-ACC	3	2X350	D 3 16 Y	3.183	930x680x456	3.696,90
021506	P-FL018Z2012-ACC	3	2X350	D 3 18 Y	3.731	930x680x456	3.795,40
021525	P-FL021Z12012-ACC	4	2X350	Q 4 21 Y	3.734	930x680x606	4.726,60
021508	P-FL025Z2012-ACC	4	2X350	Q 4 25 Y	4.794	930x680x606	4.992,20
021509	P-FL028Z2012-ACC	5	2X400	Q 5 28 Y	5.441	1.110x785x626	5.373,50
021535	P-FL042Z2012-ACC	8	2X450	S 8 42 Y	8.366	1.110x785x726	6.579,70
021511	P-FL051Z2012-ACC	10	2X450	S 10 52 Y	10.871	1.315x870x852	7.487,50
021512	P-FL056Z2012-ACC	15	2X450	S 15 56 Y	11.563	1.315x870x852	8.089,10
021513	P-FL071Z2012-ACC	15	2X560	V 15 71 Y	14.548	1.650x1.030x876	11.142,20
021514	P-FL084Z2012-ACC	20	2X560	V 20 84 Y	17.827	1.650x1.030x876	11.654,70

**** TUTTE LE UNITA' SONO EQUIPAGGIATE DI FILTRO, INDICATORE DI UMIDITA', PRESSOSTATO
 DOPPIO - RESIST. CARTER SU UNITA' DI BASSA / ALL CONDENSING UNITS ARE SUPPLIED WITH FILTER DRIER, MOISTURE
 INDICATOR, DUAL PRESSURE SWITCH - CRANCKASE OIL HEATER ONLY ON LOW TEMP. UNIT**



"PED APPROVED"

"ECODESIGN AVAILABLE"

UNITA' CONDENSATRICI SEMIERMETICHE AD ARIA

SEMI-HERMETIC CONDENSING UNITS

UNITA' CONDENSATRICI SEMIERMETICHE AD ARIA 2 VENTILATORI CON COMPRESSORE BITZER **

AIR-COOLED SEMIHERMETIC CONDENSING UNITS WITH 2 FAN MOTORS - BITZER COMPRESSOR EQUIPPED **

CODICE CODE	MODELLO MODEL	VENT. FANS	COMPR. COMPRES. TYPE	W.RESI W.OUTPUT	DIMENSIONI DIMENSIONS LxPxH	LISTINO PRICE LIST Euro
R404A MHBP - Voltaggio standard / Standard voltage 400/3/50				-10te/+32°Cta		
NC	P-BH004Z2012-ACC	2X300	2-KES05	1.923	800x560x415	2.957,00
NC	P-BH005Z2012-ACC	2X300	2-JES07Y	2.576	800x560x415	3.041,00
NC	P-BH007Z2012-ACC	2X350	2-HES2Y	3.371	930x680x456	3.296,00
NC	P-BH008Z2012-ACC	2X350	2-GES2Y	3.885	930x680x456	3.346,00
NC	P-BH009Z2012-ACC	2X350	2-FES3Y	4.790	930x680x456	3.497,00
NC	P-BH011Z2012-ACC	2X350	2-EES3Y	5.695	930x680x456	3.721,00
NC	P-BH013Z2012-ACC	2X350	2-DES3Y	6.701	930x680x456	3.930,00
NC	P-BH016Z2012-ACC	2X350	2-CES4Y	8.255	930x680x456	4.383,00
NC	P-BH018Z2012-ACC	2X400	4-FES5Y	8.943	1.110x785x626	4.877,00
NC	P-BH021Z2012-ACC	2X450	4-EES6Y	11.318	1.110x785x726	5.254,00

R404A LBP - Voltaggio standard / Standard voltage 400/3/50

-30te/+32°Cta

NC	P-BL007Z2012-ACC	2X300	2-HES1Y	1.195	800x560x415	3.091,00
NC	P-BL010Z2012-ACC	2X300	2-FES2Y	1.811	800x560x415	3.183,00
NC	P-BL013Z2012-ACC	2X350	2-DES2Y	2.512	930x680x456	3.785,00
NC	P-BL016Z2012-ACC	2X350	2-CES3Y	3.121	930x680x456	3.886,00
NC	P-BL018Z2012-ACC	2X350	4-FES3Y	3.422	930x680x456	4.393,00
NC	P-BL025Z2012-ACC	2X350	4-EES4Y	4.176	930x680x606	4.586,00
NC	P-BL028Z2012-ACC	2X400	4-DES5Y	5.145	1110X785X626	4.913,00

** TUTTE LE UNITA' SONO EQUIPAGGIATE DI FILTRO, INDICATORE DI UMIDITA', PRESSOSTATO

DOBPIO - RESIST. CARTER SU UNITA' DI BASSA / ALL CONDENSING UNITS ARE SUPPLIED WITH FILTER DRIER, MOISTURE INDICATOR, DUAL PRESSURE SWITCH - CRANCKASE OIL HEATER ONLY ON LOW TEMP. UNIT

ACCESSORI OPZIONALI MONTATI / MOUNTED ACCESSORIES

021428	SOLEN. <15 HP	valv. Solenoide montata fino 15Hp / solenoid valve <15 hp	155,10
021429	SOLEN. >15 HP	valv. Solenoide montata oltre 15Hp / solenoid valve >15 hp	212,30
021430	KIT-SL-H1	separat. Liquido c/valv.sicur.e antiv. / Suction accumulator (0,5 - 2HP)	436,70
021435	KIT-SL-H2	separat. Liquido c/valv.sicur.e antiv. / Suction accumulator (3 - 5 HP)	485,10
021440	KIT-SL-H3	separat. Liquido c/valv.sicur.e antiv. / Suction accumulator (5 - 10 HP)	620,40
PRESS.01	press.vent.	press. Parzial, ventola condensatore / fan switch	139,30
021445	KIT-SO-E1	separat. d'olio c/rubinetto-filtro- indicatore. / Oil separator kit	625,90
NC	WPH - 01	CARENATURA 2 X 300 / 2 X 300 Housing	490,00
NC	WPH - 02	CARENATURA 2 X 350 / 2 X 350 Housing	628,00
NC	WPH - 03	CARENATURA 2 X 400 / 2 X 400 Housing	742,00
NC	WPH - 04	CARENATURA 2 X 450 / 2 X 400 Housing	905,00
NC	WPH - 05	CARENATURA 2 X 560 / 2 X 400 Housing	1.682,00
NC	WPH - 06	CARENATURA 2 X 630 / 2 X 400 Housing	2.053,00



RIVACOLD
MASTERING COLD



"PED APPROVED"

"ECODESIGN AVAILABLE"

UNITA' CONDENSATRICI SEMIERMETICHE AD ARIA LA BLU-FRASCOLD

LA BLU - FRASCOLD SEMI-HERMETIC CONDENSING UNITS

UNITA' CONDENSATRICI SEMIERMETICHE AD ARIA 2 VENTILATORI CON COMPRESSORE FRASCOLD

AIR-COOLED SEMIHERMETIC CONDENSING UNITS WITH 2 FAN MOTORS - FRASCOLD COMPRESSOR EQUIPPED



CODICE CODE	MODELLO MODEL	HP NOM. HP	COMPR. COMPRES. TYPE	W.RESI W.OUTPUT	MRA - A MRA-A MRA - A	DIMENSIONI DIMENSIONS LxPxH	CARENATURA HOUSING "OPTIONAL"	LISTINO PRICE LIST Euro
R404A MHBP - V. 400/3/50				-10te/+32°Cta				
GAA075	LB-A075-0Y-2M	0,75	A0-75Y	2.388	2,7	796X620X368	USH0U19	2.669,30
GAA106	LB-A106-0Y-2M	1	A1-06	2.877	3,6	796X620X418	USH0U18	2.669,30
GAA157	LB-A157-0Y-2M	1,5	A1,5-7Y	3.626	4,5	796X620X418	USH0U18	2.750,30
GAB210	LB-B210-0Y-2M	2	B2-10Y	4.669	6,7	796X620X418	USH0U18	3.007,40
GAD211	LB-D211-0Y-2M	2	D2-11Y	6.033	7,1	987X700X506	USH0U17	3.647,70
GAD211-T	LB-D211-0Y-2-TROP	2	D2-11Y	6.252	7,1	1060X760X575	USHU016	3.926,00
GAD313	LB-D313-0Y-2M	3	D3-13Y	6.242	8,8	987X700X506	USH0U17	3.709,80
GAD313-T	LB-D313-0Y-2-TROP	3	D3-13Y	7.596	8,8	1420X760X689	USHU015	4.563,00
GAD416	LB-D416-0Y-2M	4	D4-16Y	8.826	11,6	1060X760X575	USH0U16	3.717,60
GAD416-T	LB-D416-0Y-2-TROP	4	D4-16Y	9.437	11,6	1420X760X689	USHU015	4.581,30
GAQ521	LB-Q521-0Y-2M	5	Q5-21Y	11.282	11,6	1420X760X689	USHU015	5.800,80
GAQ521-T	LB-Q521-0Y-2-TROP	5	Q5-21Y	12.038	11,6	1570X830X864	USHU014	6.440,00
GAQ728	LB-Q728-0Y-2M	7,5	Q7-28Y	14.685	17,6	1420X760X689	USHU015	6.143,40
GAQ728-T	LB-Q728-0Y-2-TROP	7,5	Q7-28Y	15.944	17,6	1570X830X864	USHU014	6.859,70

COSTO ACCESSORI MONTATI / ACCESSORIES PRICE

linea liquido: antivibrante linea aspirazione-filtro-indicatore-solenoide Danfoss-press. Doppio

ACCESSORIES: suction line vibrating eliminator-drier-sight-glass-Danfoss solenoid- dual pressure switch

MODELLO MODEL	LINEA LIQUIDO LIQUID.LINE	SEPARAT. OLIO OIL SEP.	PRESS.PARZ. VENT. COND. PRESS.SWITCH	CARENATURA HOUSING "OPTIONAL"
LB-A075-0Y-2M	0,75	LI-01	PRESS-01	USH0U19
LB-A106-0Y-2M	1	LI-01	PRESS-01	USH0U18
LB-A157-0Y-2M	1,5	LI-02	PRESS-01	USH0U18
LB-B210-0Y-2M	2	LI-03	PRESS-01	USH0U18
LB-D211-0Y-2M	2	LI-03	PRESS-01	USH0U17
LB-D211-0Y-2-TROP	2	LI-03	PRESS-01	USHU016
LB-D313-0Y-2M	3	LI-04	PRESS-01	USH0U17
LB-D313-0Y-2-TROP	3	LI-04	PRESS-01	USHU015
LB-D416-0Y-2M	4	LI-05	PRESS-01	USH0U16
LB-D416-0Y-2-TROP	4	LI-05	PRESS-01	USHU015
LB-Q521-0Y-2M	5	LI-06	PRESS-01	USH0U15
LB-Q521-0Y-2-TROP	5	LI-06	PRESS-01	USHU014
LB-Q728-0Y-2M	7,5	LI-07	PRESS-01	USH0U15
LB-Q728-0Y-2-TROP	7,5	LI-07	PRESS-01	USHU014



CODICE CODE	LISTINO PRICE LIST Euro	CODICE CODE	LISTINO PRICE LIST Euro	CODICE CODE	LISTINO PRICE LIST Euro
LI-01	692,60	OIL-01	552,30	USHU019	567,70
LI-02	736,30	OIL-02	567,70	USHU018	567,70
LI-03	943,60	OIL-03	578,30	USHU017	651,60
LI-04	990,10	OIL-04	599,90	USHU016	762,40
LI-05	1.011,80	PRESS.01	139,30	USHU015	915,90
LI-06	1.167,00			USHU014	1.103,30
LI-07	1.203,70				

UNITA' CONDENSATRICI SEMIERMETICHE AD ARIA LA BLU-FRASCOLD

LA BLU - FRASCOLD SEMI-HERMETIC CONDENSING UNITS

UNITA' CONDENSATRICI SEMIERMETICHE AD ARIA 2 VENTILATORI CON COMPRESSORE FRASCOLD

AIR-COOLED SEMIHERMETIC CONDENSING UNITS WITH 2 FAN MOTORS - FRASCOLD COMPRESSOR EQUIPPED



CODICE CODE	MODELLO MODEL	HP NOM. HP	COMPR. COMPRES. TYPE	W.RESI W.OUTPUT	MRA - A MRA-A MRA - A	DIMENSIONI DIMENSIONS LxPxH	CARENATURA HOUSING "OPTIONAL"	LISTINO PRICE LIST Euro
R404A MLBP - V. 400/3/50				-30te/+32° Cta				
GAA107	LB-A107-0Y-2M	1	A1-07Y	1.493	3,7	796X620X418	USHU018	2.669,30
GAB159	LB-B159-0Y-2M	1,5	B1,5-9Y	1868	5,9	796X620X418	USHU018	2.801,90
GAD213	LB-D213-0Y-2M	2	D2-13Y	3.042	7,1	987X500X506	USHU017	3.625,00
GAD213-T	LB-D213-0Y-2-TROP	2	D2-13Y	3.102	7,1	1060X760X575	USHU016	3.926,00
GAD316	LB-D316-0Y-2M	3	D3-16Y	3.624	9,9	987X500X506	USHU017	3.709,80
GAD316-T	LB-D316-0Y-2-TROP	3	D3-16Y	3.859	9,9	1420X760X689	USHU015	4.563,00
GAD318	LB-D318-0Y-2M	3	D3-18Y	4.194	10,0	987X500X506	USHU017	3.676,60
GAD318-T	LB-D318-0Y-2-TROP	3	D3-18Y	4.310	10,0	1060X760X575	USHU016	4.052,40
GAQ424	LB-Q424-0Y-2M	4	Q4-24Y	5.000	11,7	1060X760X575	USHU016	5.139,40
GAQ424-T	LB-Q424-0Y-2-TROP	4	Q4-24Y	5.266	11,7	1420X760X689	USHU015	5.554,70
GAQ533	LB-Q533-0Y-2M	5	Q5-33Y	7.107	14,4	1060X760X575	USHU016	5.503,10
GAQ533-T	LB-Q533-0Y-2-TROP	5	Q5-33Y	7.586	14,4	1420X760X689	USHU015	6.268,20
GAQ842	LB-Q842-0Y-2M	8	Q8-42Y	9.416	20,3	1420X820X689	USHU013	7.013,70
GAQ842-T	LB-Q842-0Y-2-TROP	8	Q8-42Y	10.040	20,3	1570X830X864	USHU014	7.599,10

COSTO ACCESSORI MONTATI / ACCESSORIES PRICE

linea liquido: antivibrante linea aspirazione-filtro-indicatore-solenoid Danfoss-press. Doppio

ACCESSORIES: suction line vibrating eliminator-drier-sight-glass-Danfoss solenoid- dual pressure switch

MODELLO MODEL	LINEA LIQUIDO	SEPARAT. OLIO	PRESS.PARZ. VENT. COND.	CARENATURA HOUSING	
	LIQUID.LINE	OIL SEP.	PRESS.SWITCH		
LB-A107-0Y-2M	1	LI-01	OIL-01	PRESS-01	USHU018
LB-B159-0Y-2M	1,5	LI-02	OIL-01	PRESS-01	USHU018
LB-D213-0Y-2M	2	LI-03	OIL-02	PRESS-01	USHU017
LB-D213-0Y-2-TROP	2	LI-03	OIL-02	PRESS-01	USHU016
LB-D316-0Y-2M	3	LI-04	OIL-02	PRESS-01	USHU017
LB-D316-0Y-2-TROP	3	LI-04	OIL-02	PRESS-01	USHU015
LB-D318-0Y-2M	3	LI-04	OIL-02	PRESS-01	USHU017
LB-D318-0Y-2-TROP	3	LI-04	OIL-02	PRESS-01	USHU016
LB-Q424-0Y-2M	4	LI-05	OIL-03	PRESS-01	USHU016
LB-Q424-0Y-2-TROP	4	LI-05	OIL-03	PRESS-01	USHU015
LB-Q533-0Y-2M	5	LI-06	OIL-03	PRESS-01	USHU016
LB-Q533-0Y-2-TROP	5	LI-06	OIL-03	PRESS-01	USHU015
LB-Q842-0Y-2M	8	LI-07	OIL-05	PRESS-01	USHU013
LB-Q842-0Y-2-TROP	8	LI-07	OIL-05	PRESS-01	USHU014



CODICE CODE	LISTINO PRICE LIST Euro	CODICE CODE	LISTINO PRICE LIST Euro	CODICE CODE	LISTINO PRICE LIST Euro
LI-01	692,60	OIL-01	552,30	USHU018	567,70
LI-02	736,30	OIL-02	567,70	USHU017	651,60
LI-03	943,60	OIL-03	578,30	USHU016	762,40
LI-04	990,10	OIL-04	599,90	USHU015	915,90
LI-05	1.011,80	PRESS.01	139,30	USHU014	1.103,30
LI-06	1.167,00			USHU013	846,10
LI-07	1.203,70				

UNITA' CONDENSATRICI CARENATE SILENZIATE

NOISE INSULATION HOUSING CONDENSING UNITS

ERM/ERL



UNITA' CONDENSATRICI AD ARIA CARENATE CON COMPRESSORE ALTERNATIVO MOD. ME-EASY

ME-EASY -AIR-COOLED HOUSING CONDENSING UNITS - HERMETIC RECIPROCATING COMPRESSOR EQUIPPED

MODELLO MODEL	HP NOM. HP	COMPR. COMPRESS.	Rumoros. Noise lev. dba (10m)	W.RESI W.OUTPUT -10te/+32°Cta	DIMENSIONI DIMENSIONS LxPxH mm	ATTACCHI CONNEX. mm	LISTINO PRICE LIST Euro
------------------	------------------	---------------------	-------------------------------------	-------------------------------------	--------------------------------------	---------------------------	-------------------------------

R404A/452A MHBP TENSIONE V.230/1/50

ERM140Z0111	0,5	HERMETIC	36	800	1016X420X580	06 X10	2.617,00
ERM140Z5111	0,5+	HERMETIC	36	1.192	1016X420X580	06 X10	2.705,00
ERM140Z2111	0,75	HERMETIC	36	1.286	1016X420X580	06 X10	2.797,00
ERM140Z3111	1	HERMETIC	39	1.639	1016X420X580	06 X12	2.922,00
ERM140Z0211	1+	HERMETIC	39	1.958	1016X420X580	06 X12	3.102,00
ERM140Z1211	1,25	HERMETIC	41	2.249	1016X420X580	10 X 16	3.192,00
ERM140Z2211	1,5	HERMETIC	41	2.758	1016X420X580	10 X 16	3.280,00

R404A/452A MHBP TENSIONE V.400/3/50 -10te/+32°Cta

ERM145Z0212	2	HERMETIC	41	3.451	1156X420X785	10 X 16	3.557,00
ERM145Z1212	2,5	"	43	4.285	1156X420X785	10 X 22	3.829,00
ERM145Z0312	3	"	46	5.503	1156X420X785	10 X 22	4.000,00
ERM245Z0212	4	"	50	6.316	1306X470X1160	12 X 22	4.957,00
ERM245Z1212	4,5	"	50	7.005	1306X470X1160	12 X 22	5.145,00
ERM245Z2212	5	"	51	7.746	1306X470X1160	12 X 28	5.320,00
ERM245Z0312	6	"	51	9.253	1306X470X1160	12 X 28	5.577,00
ERM245Z1312	6,25	"	50	9.825	1306X470X1160	12 X 28	5.657,00

R404A/452A LBP TENSIONE V.400/3/50 -30te/+32°Cta

ERL145Z0112	2	HERMETIC	41	1.428	1155X420X785	10 X 16	3.617,00
ERL145Z1112	3	"	43	1.792	1155X420X785	10 X 16	3.710,00
ERL245Z3112	4	"	44	2.476	1302X470X1160	12 X 22	4.484,00
ERL245Z2112	4	"	45	3.788	1302X470X1160	12 X 22	4.969,00

LE UNITA' VENGONO FORNITE COMPLETE DI FILTRO, INDICATORE E PRESSOSTATO HP/BP MONTATI
 ALL CONDENSING UNITS ARE SUPPLIED WITH FILTER DRIER, MOISTURE INDICATOR AND HP/BP
 PRESSURE SWITCH MOUNTED

COMPLETE DI QUADRO A BORDO MACCHINA FORNITO DI SEZIONATORE / BUILT IN ELECTRICAL BOX EQUIPPED

UNITA' CONDENSATRICI CARENATE SILENZIATE

NOISE INSULATION HOUSING CONDENSING UNITS

ERM/ERL



UNITA' CONDENSATRICI AD ARIA CARENATE CON COMPRESSORE ALTERNATIVO MOD. ME-EASY

ME-EASY -AIR-COOLED HOUSING CONDENSING UNITS - HERMETIC RECIPROCATING COMPRESSOR EQUIPPED

MODELLO MODEL	HP NOM. HP	COMPR. COMPRESS. TYPE	Rumoros. Noise lev. dba (10m)	W.RESI W.OUTPUT -10te/+32°Cta	DIMENSIONI DIMENSIONS LxPxH mm	ATTACCHI CONNEC. mm	LISTINO PRICE LIST €uro
------------------	------------------	-----------------------------	-------------------------------------	-------------------------------------	--------------------------------------	---------------------------	-------------------------------

R134A MHBP TENSIONE V.230/1/50

ERM140Y0111	0,5	HERMETIC	32	1.067	1016X420X580	06 X10	2.646,00
ERM140Y1111	0,5+	HERMETIC	32	1.281	1016X420X580	06 X10	2.735,00
ERM140Y2111	0,75+	HERMETIC	32	1.488	1016X420X580	06 X10	2.806,00
ERM140Y3111	1	HERMETIC	32	1.595	1016X420X580	06 X12	2.879,00
ERM140Y0211	1,25	HERMETIC	33	2.668	1016X420X580	06 X12	3.161,00
ERM145Y0211	1,5	HERMETIC	35	3.961	1155X420X785	10 X 16	3.870,00

R134A MHBP TENSIONE V.400/3/50 -10te/+32°Cta

ERM145Y0212	1,5	HERMETIC	35	3.961	1156X420X785	10 X 16	3.784,00
ERM145Y1212	2	"	38,5	5.021	1156X420X785	10 X 22	4.075,00
ERM245Y0212	2,75	"	41	6.880	1156X420X785	10 X 22	5.274,00
ERM245Y1212	3	"	41,5	8.040	1306X470X1160	12 X 22	5.475,00

UNITA' CONDENSATRICI AD ARIA CARENATE CON COMPRESS. SCROLL DIGITAL A CAP. VARIABILE

AIR-COOLED HOUSING CONDENSING UNITS -VARIABLE CAPACITY SCROLL COMPRESSOR EQUIPPED

R134A MHBP TENSIONE V.400/3/50

MODELLO MODEL	RIF. REF.	COMPR. COMPRESS.	Rumoros. Noise lev. dba (10m)	W.RESI W.OUTPUT -10te/+32°Cta	DIMENSIONI DIMENSIONS LxPxH mm	ATTACCHI CONNEC. mm	LISTINO PRICE LIST €uro
------------------	--------------	---------------------	-------------------------------------	-------------------------------------	--------------------------------------	---------------------------	-------------------------------

HCM140YD212	B1	ZBD21KCE-TFD	36	329 / 3176	1032x450x751	10x18	7339,00
HCM145YD222	B1	ZBD38KCE-TFD	42,5	553 / 5281	1182x450x901	12x22	9542,00
HCM145YD312	B1	ZBD45KCE-TFD	38	640 / 6091	1182x450x901	12x22	10352,00
HCM245YD352	B2	ZBD57KCE-TFD	44	827 / 8031	1302x450x1201	12x28	12000,00
HCM245YD322	B2	ZBD76KCE-TFD	42,5	1080 / 10115	1302x450x1201	16x35	13369,00

SEP-OIL SEPARATORE OLIO 620,00

MOTOV. ELETT .B1 VENT. ELETTRONICI 193,00

MOTOV. ELETT .B2 VENT. ELETTRONICI 613,00

EVAPORATORI VENTILATI RIVACOLD

RIVACOLD UNIT COOLERS

EVAPORATORI VENTILATI RIVACOLD COMPATTI SERIE RS-RSV

RS RIVACOLD COMPACT UNIT COOLERS



CODICE CODE	MODELLO MODEL	DIMENSIONI DIMENSIONS mm	PASSO AL. FIN SPAC. mm	VENT. FANS n° x Diam.	SBRINAM. DEFROST W	RESA CAPAC. DT=10K Kw	P.ARIA AIR FL. mc/h	F.ARIA AIR TH. m	LISTINO PRICE LIST Euro
040400	RS-1040ED	404x360x119	3,5 / 7	1x200	400	0,406	223	3,0	227,00
040402	RS-1060ED	404x433x119	3,5 / 7	1x200	400	0,595	195	2,5	242,00
040404	RS-2100ED	604x433x119	3,5 / 7	2x200	650	0,741	382	3,0	334,00
040406	RS-2130ED	604x433x119	3,5 / 7	2x200	650	1,010	337	2,5	354,00
040408	RS-3180ED	1104x433x119	3,5 / 7	3x200	1000	1,390	705	3,0	508,00
040410	RS-3290ED	1104x433x119	3,5 / 7	3x200	1000	1,910	595	2,5	553,50
040424	RS-4380ED	1379x433x119	3,5 / 7	4x200	1300	2,360	784	2,5	668,00
040412	RS-1040BED	404x360x119	4,5 / 9	1x200	400	0,346	243	3,0	277,00
040414	RS-1060BED	404x433x119	4,5 / 9	1x200	400	0,474	213	2,5	291,00
040416	RS-2100BED	604x433x119	4,5 / 9	2x200	650	0,579	426	3,0	383,50
040418	RS-2130BED	604x433x119	4,5 / 9	2x200	650	0,707	382	2,5	407,00
040420	RS-3180BED	1104x433x119	4,5 / 9	3x200	1000	1,110	773	3,0	560,00
040422	RS-3290BED	1104x433x119	4,5 / 9	3x200	1000	1,380	684	2,5	603,00
040426	RS-4380BED	1379x433x119	4,5 / 9	4x200	1300	1,570	866	2,5	727,00
040401	RSV1200405-ED	656X433X183	5	1x200	650	1,080	630	**	464,90
040403	RSV1200605-ED	656X433X183	5	1x200	650	1,410	600	**	514,80
040405	RSV2200405-ED	1106X433X183	5	2x200	1200	2,030	1.230	**	654,20
040407	RSV2200605-ED	1106X433X183	5	2x200	1200	2,650	1.170	**	726,00

EVAPORATORI VENTILATI A SOFFITTO RIVACOLD SERIE RSI

RSI RIVACOLD CEILING UNIT COOLERS



CODICE CODE	MODELLO MODEL	DIMENSIONI DIMENSIONS mm	PASSO AL. FIN SPAC. mm	VENT. FANS n° x Diam.	SBRINAM. DEFROST W	RESA CAPAC. DT=10K	P.ARIA AIR FL. mc/h	F.ARIA AIR TH. m	LISTINO PRICE LIST Euro
040430	RSI-1250-ED	565x461x241H	5,3	1x250	500	1,280	583	6,5	663,60
040432	RSI-2250-ED	935x461x241H	5,3	2x250	900	2,530	1.138	7,0	889,20
040434	RSI-3250-ED	1.305x461x241H	5,3	3x250	1300	3,850	1.706	8,5	1.129,50
040436	RSI-4250-ED	1.675x461x241H	5,3	4x250	1800	4,970	2.275	9,5	1.344,80
040438	RSI-23503-ED	1.300x726x287H	3,5	2x350	2800	5,750	2.391	10,0	1.591,20
040440	RSI-33503-ED	1.750x726x287H	3,5	3x350	4096	8,250	3.459	11,0	2.162,20
040442	RSI-43503-ED	2.200x726x287H	3,5	4x350	5360	11,000	4.613	12,0	2.774,80
040444	RSI-23507-ED	1.300x726x287H	7,0	2x350	2800	4,130	3.150	12,0	1.560,00
040446	RSI-33507-ED	1.750x726x287H	7,0	3x350	4096	5,780	4.598	12,5	2.114,40
040448	RSI-43507-ED	2.200x726x287H	7,0	4x350	5360	7,960	5.963	13,0	2.715,50

EVAPORATORI VENTILATI RIVACOLD

RIVACOLD UNIT COOLERS

EVAPORATORI VENTILATI CUBICI A SOFFITTO RIVACOLD SERIE RC

RC RIVACOLD CEILING CUBIC UNIT COOLERS

RIVACOLD
MASTERING COLD



CODICE CODE	MODELLO MODEL	DIMENSIONI DIMENSIONS mm	PASSO AL. FIN SPAC. mm	VENT. FANS n° x Diam.	SUPERF. SURFACE mq	RESA CAPACITY DT=10K Kw	P.ARIA AIR FLOW mc/h	F.ARIA AIR THR. m	LISTINO PRICE LIST €uro
040460	RC-125-16ED	574x402x350H	5,3	1x250	5,59	1,760	736	7,0	715,60
040462	RC-225-25ED	944x402x350H	5,3	2x250	7,36	2,740	1.602	7,5	878,80
040464	RC-225-30ED	944x402x350H	5,3	2x250	11,00	3,480	1.445	7,0	962,00
040466	RC-325-33ED	1314x402x350H	5,3	3x250	11,00	4,140	2.364	7,5	1.088,90
040468	RC-325-45ED	1314x402x350H	5,3	3x250	16,50	4,960	2.167	7,0	1.182,50
040470	RC-425-61ED	1684x402x350H	5,3	4x250	21,90	6,870	2.890	7,0	1.610,00

EVAPORATORI VENTILATI RIVACOLD DOPPIO FLUSSO SERIE RDF

RIVACOLD RDF SERIES DOUBLE FLUX UNIT COOLERS

RIVACOLD
MASTERING COLD

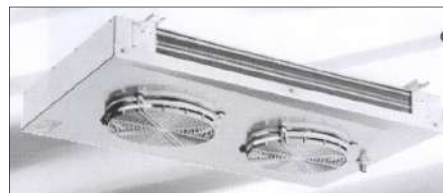

CODICE CODE	MODELLO MODEL	DIMENSIONI DIMENSIONS mm	PASSO AL. FIN SPAC. mm	VENT. FANS n° x Diam.	SUPERF. SURFACE mq	RESA CAPAC. DT=10K Kw	P.ARIA AIR FL. mc/h	F.ARIA AIR TH. m	LISTINO PRICE LIST €uro
040449	RDF-1250-ED	522x638x155H	4,5 / 9	1x250	3,55	1,160	483	3,0	533,00
040450	RDF-2250-ED	922x638x155H	4,5 / 9	2x250	8,07	2,350	1.052	4,0	831,00
040451	RDF-3250-ED	1322x638x155H	4,5 / 9	3x250	12,60	3,910	1.621	8,0	1.095,00
040447	RDF-4250-ED	1722x638x160H	4,5 / 9	4x250	17,10	5,340	2.162	10,0	1.386,00
040452	RDF-23503-ED	1.366x756x241H	3,5	2x350	27,50	6,23/7,29	2.848/3.817	8 / 10	1.699,00
040453	RDF-33503-ED	1.816x756x246H	3,5	3x350	39,30	8,76/10,10	4.100/5.511	10 / 11	2.449,00
040454	RDF-43503-ED	2.266x756x251H	3,5	4x350	51,10	11,60/13,40	5.354/7.062	11 / 12	3.077,00
040455	RDF-53503-ED	2.716x756x256H	3,5	5x350	62,90	13,90/16,00	6.550/8.828	12 / 14	3.872,00
040456	RDF-23507-ED	1.366x756x241H	7,0	2x350	14,60	4,32/4,82	3.587/4.530	9 / 10	1.679,00
040457	RDF-33507-ED	1.816x756x246H	7,0	3x350	20,90	5,67/6,24	5.295/6.688	11 / 12	2.417,00
040458	RDF-43507-ED	2.266x756x251H	7,0	4x350	27,10	7,88/8,77	6.947/8.775	12 / 14	2.999,00
040459	RDF-53507-ED	2.716x756x256H	7,0	5x350	33,40	9,02/9,86	8.540/10.968	14 / 15	3.822,00

EVAPORATORI VENTILATI RIVACOLD

RIVACOLD UNIT COOLERS



EVAPORATORI VENTILATI CUBICI A SOFFITTO RIVACOLD SERIE RCM-R (TUBO RIGATO)

RCM-R RIVACOLD CEILING RIFLED TUBED UNIT COOLERS

CODICE CODE	MODELLO MODEL	DIMENSIONI DIMENSIONS mm	PASSO AL. FIN SPAC. mm	VENT. FANS n° x Diam.	SUPERF. SURFACE mq	RESA CAPACITY DT=10K	P.ARIA AIR FLOW mc/h	F.ARIA AIR THR. m	LISTINO PRICE LIST Euro
040473	RCMR-1350604-ED	944x554x475H	4,0	1x350	23,90	6,40	2.081,5	10	1.463,30
040475	RCMR-2350404-ED	1304x554x475H	4,0	2x350	24,30	9,43	4.078,0	14	1.767,00
040477	RCMR-2350804-ED	1304x554x475H	4,0	2x350	48,60	11,30	3.150,0	14	2.281,80
040479	RCMR-3350604-ED	1754x554x475H	4,0	3x350	52,00	15,40	4.978,0	15	2.852,80
040481	RCMR-4350604-ED	2204x554x475H	4,0	4x350	67,60	20,70	6.637,5	18	3.587,00
040483	RCMR-1350606-ED	944x554x475H	6,0	1x350	16,50	5,76	2.170,5	11	1.402,00
040485	RCMR-2350406-ED	1304x554x475H	6,0	2x350	16,80	8,15	4.287,0	14	1.720,20
040487	RCMR-2350806-ED	1304x554x475H	6,0	2x350	33,50	11,20	3.656,5	14	2.187,20
040489	RCMR-3350606-ED	1754x554x475H	6,0	3x350	35,90	15,00	5.990,0	16	2.766,40
040491	RCMR-4350606-ED	2204x554x475H	6,0	4x350	46,70	20,10	7.987,5	21	3.477,80
040493	RCMR-1350608-ED	944x554x475H	8,0	1x350	12,80	3,99	2.251,5	11	1.371,80
040495	RCMR-2350408-ED	1304x554x475H	8,0	2x350	13,00	5,84	4.503,0	14	1.700,40
040497	RCMR-2350808-ED	1304x554x475H	8,0	2x350	26,00	8,30	4.162,5	14	2.172,60
040499	RCMR-3350608-ED	1754x554x475H	8,0	3x350	27,90	10,90	6.497,0	16	2.748,80
040502	RCMR-4350608-ED	2204x554x475H	8,0	4x350	36,20	14,90	8.662,5	23	3.409,20

EVAPORATORI VENTILATI PER SOTTOBANCHI SERIE RM

RM DISPLAY CASES UNIT COOLERS



GAMMA CON FISSAGGIO A PARETE / WALL APPLICATION RANGE

CODICE CODE	MODELLO MODEL	DIMENSIONI DIMENSIONS mm	PASSO AL. FIN SPAC. mm	RESA CAPACITY DT=10K	P.ARIA AIR FLOW mc/h	LISTINO PRICE LIST Euro
040298	RM70/347	390 x 330	4,5	406,0	127,50	276,70
040300	RM70/348	390 x 355	4,5	458,0	122,50	286,00
040302	RM70/349	390 x 405	4,5	546,0	115,00	306,80
040297	RM70/350	390 x 455	4,5	607,0	110,00	313,10
040301	RM70/420	440 x 505	4,5	657,0	100,00	371,30

GAMMA CON FISSAGGIO CENTRALE / CENTRAL APPLICATION RANGE

040304	RM70/347C	390 x 330	4,5	406,0	127,50	284,00
040306	RM70/348C	390 x 355	4,5	458,0	122,50	286,00
040308	RM70/349C	390 x 405	4,5	546,0	115,00	304,80
040299	RM70/350C	390 x 455	4,5	607,0	110,00	308,90
040303	RM70/420C	440 x 505	4,5	657,0	100,00	362,00

V004608 V004610 VASCHETTA RACCOGLI CONDENSA PER RM70 mm. 420X68X83 32,00

LE BATTERIE DEGLI AEROEVAPORATORI SERIE RM SONO TRATTATE CON SPECIALI VERNICI ANTICORROSIONE
RM BATTERIES ARE PAINTED AND CORROSION RESISTENT

EVAPORATORI VENTILATI LUVATA

LUVATA UNIT COOLERS

EVAPORATORI VENTILATI COMPATTI ECO SERIE: EVS / EVSB

EVS / EVS B / COOLERS

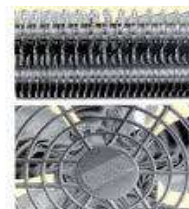

CODICE CODE	MODELLO MODEL	DIMENSIONI DIMENSIONS mm	RESA CAPACITY KW.DT=10K	VENT. FANS n° x Diam.	P.ARIA AIR FLOW mc/h	F.ARIA AIR THR. m	PASSO AL. FIN SPAC. mm	LISTINO PRICE LIST Euro
040512	EVS41-ED	411X270X120	0,43	1X200	290	3	3,5 / 7	228,10
040514	EVS61-ED	411X270X120	0,53	1X200	260	2,5	3,5 / 7	253,40
040516	EVS101-ED	611X471X120	0,84	2X200	580	5,0	3,5 / 7	347,00
040518	EVS131-ED	611X471X120	1,01	2X200	520	4,5	3,5 / 7	378,00
040520	EVS181-ED	1111X971X120	1,70	3X200	870	4,5	3,5 / 7	545,60
040522	EVS291-ED	1111X971X120	2,06	3X200	870	4,0	3,5 / 7	607,80
040523	EVS201-ED	611X471X170	1,46	2X200	565	4,0	3,5 / 7	588,40
040524	EVS271-ED	861X721X70	1,73	2X200	691	4,0	3,5 / 7	753,90
040525	EVS391-ED	1111X971X170	2,52	3X200	980	4,0	3,5 / 7	935,10
040526	EVS521-ED	1461X1321X170	3,29	4X200	1300	4,0	3,5 / 7	1.285,80
040536	EVS/ B 41-ED	411X270X120	0,37	1X200	310	3,0	4,5 / 9	294,30
040538	EVS/ B 61-ED	411X270X120	0,47	1X200	280	2,5	4,5 / 9	317,80
040540	EVS/ B 101-ED	611X471X120	0,72	2X200	620	5	4,5 / 9	420,90
040542	EVS/ B 131-ED	611X471X120	0,89	2X200	560	4,5	4,5 / 9	448,30
040544	EVS/ B 181-ED	1111X971X120	1,45	3X200	930	4,5	4,5 / 9	627,50
040546	EVS/ B 291-ED	1111X971X120	1,77	3X200	830	4	4,5 / 9	682,00

EVAPORATORI VENTILATI COMPATTI ECO BIFLUSSO SERIE: MIC

DOUBLE FLUX MIC COOLERS



CODICE CODE	MODELLO MODEL	DIMENSIONI DIMENSIONS mm	RESA CAPACITY DT=10K	VENT. FANS n° x Diam.	P.ARIA AIR FLOW mc/h	F.ARIA AIR THR. m	PASSO AL. FIN SPAC. mm	LISTINO PRICE LIST Euro
040501	MIC 80-ED	130X650X172	738	1X230	540	2X3	4,5 / 9	587,60
040503	MIC 100-ED	130X650X172	825	1X230	460	2X2,5	4,5 / 9	617,60
040505	MIC 160-ED	730X650X185	1463	2X230	1080	2X3	4,5 / 9	863,20
040507	MIC 200-ED	730X650X185	1663	2X230	920	2X2,5	4,5 / 9	933,20
040509	MIC 300-ED	1030X650X185	2488	3X230	1380	2X2,5	4,5 / 9	1.228,90
040511	MIC 400-ED	1330X650X185	3325	4X230	1840	2X2,5	4,5 / 9	1.514,50
040513	MIC 500-ED	1630X650X185	4163	5X230	2300	2X2,5	4,5 / 9	1.814,20

EVAPORATORI STATICI

GRAVITY COILS

EVAPORATORI STATICI PER SOTTOBANCO

DISPLAY CASES GRAVITY COILS

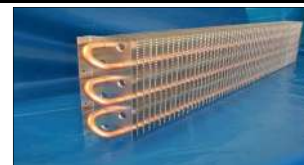

CODICE <i>CODE</i>	MODELLO <i>MODEL</i>	DIMENSIONI <i>DIMENSIONS</i>	SUPERFICIE <i>SURFACE</i>	N° TUBI <i>NR. OF TUBES</i>	RESA DT=10K <i>CAPACITY</i>	LISTINO <i>PRICE LIST</i>
		mm	mq		watt	€uro
040000	SSB402835	400x280x35	0,42	8	45	101,00
040002	SSB502835	500x280x35	0,55	8	50	111,00
040004	SSB702835	700x280x35	0,80	8	85	130,00
040006	SSB902835	900x280x35	1,06	8	110	149,00
040008	SSB1102835	1100x280x35	1,33	8	140	167,00
040010	SSB1302835	1300x280x35	1,60	8	165	186,00
040012	SSB1502835	1500x280x35	1,85	8	195	205,00
040014	SSB1702835	1700x280x35	2,10	8	220	223,00
040016	SSB1902835	1900x280x35	2,25	8	235	242,00
040018	SSB2102835	2100x280x35	2,60	8	270	261,00
040020	SSB404035	400x420x35	0,62	8	65	101,00
040022	SSB504035	500x420x35	0,83	8	87	111,00
040024	SSB704035	700x420x35	1,20	8	125	130,00
040026	SSB904035	900x420x35	1,60	8	167	149,00
040028	SSB1104035	1100x420x35	2,00	8	210	167,00
040030	SSB1304035	1300x420x35	2,40	8	250	186,00
040032	SSB1504035	1500x420x35	2,75	8	290	205,00
040034	SSB1704035	1700x420x35	3,15	8	330	223,00
040036	SSB1904035	1900x420x35	3,55	8	370	242,00
040038	SSB2104035	2100x420x35	3,90	8	410	261,00
040040	SSB402170	400x210x70	0,62	6	65	87,00
040042	SSB502170	500x210x70	0,83	6	87	95,00
040044	SSB702170	700x210x70	1,20	6	125	110,00
040046	SSB902170	900x210x70	1,60	6	167	124,00
040048	SSB1102170	1100x210x70	2,00	6	210	140,00
040050	SSB1302170	1300x210x70	2,40	6	250	155,00
040052	SSB1502170	1500x210x70	2,75	6	290	170,00
040054	SSB1702170	1700x210x70	3,15	6	330	185,00
040056	SSB1902170	1900x210x70	3,55	6	370	201,00
040058	SSB2102170	2100x210x70	3,90	6	410	215,00
040100	SSB402870	400x280x70	0,85	8	90	98,00
040102	SSB502870	500x280x70	1,10	8	115	107,00
040104	SSB702870	700x280x70	1,60	8	170	126,00
040106	SSB902870	900x280x70	2,10	8	220	146,00
040108	SSB1102870	1100x280x70	2,70	8	280	165,00
040110	SSB1302870	1300x280x70	3,20	8	335	185,00
040112	SSB1502870	1500x280x70	3,70	8	375	204,00
040114	SSB1702870	1700x280x70	4,20	8	440	223,00
040116	SSB1902870	1900x280x70	4,70	8	495	243,00
040118	SSB2102870	2100x280x70	5,25	8	550	262,00
040119	SSB404270	400x420x70	1,25	12	195	122,00
040120	SSB504270	500x420x70	1,65	12	260	136,00
040122	SSB704270	700x420x70	2,40	12	325	165,00
040124	SSB904270	900x420x70	3,20	12	390	194,00
040126	SSB1104270	1100x420x70	4,00	12	450	223,00
040128	SSB1304270	1300x420x70	4,80	12	520	251,00
040130	SSB1504270	1500x420x70	5,55	12	585	279,00
040132	SSB1704270	1700x420x70	6,30	12	650	308,00
040134	SSB1904270	1900x420x70	7,05	12	715	336,00
040136	SSB2104270	2100x420x70	7,80	12	780	366,00

EVAPORATORI STATICI

GRAVITY COILS

EVAPORATORI STATICI PER VETRINE REFRIGERATE

GRAVITY COILS FOR SHOW WINDOW



CODICE CODE	MODELLO MODEL	DIMENSIONI DIMENSIONS mm	SUPERFICIE SURFACE mq	N° TUBI NR. OF TUBES	RESA DT=10K CAPACITY watt	LISTINO PRICE LIST €uro
040060	SVT701414	700x140x140	1,85	8	195	130,00
040062	SVT901414	900x140x140	2,50	8	260	150,00
040064	SVT1101414	1100x140x140	3,10	8	325	165,00
040066	SVT1301414	1300x140x140	3,70	8	390	183,00
040068	SVT1501414	1500x140x140	4,35	8	450	201,00
040070	SVT1701414	1700x140x140	4,95	8	520	218,00
040072	SVT1901414	1900x140x140	5,60	8	585	236,00
040074	SVT2101414	2100x140x140	6,20	8	650	254,00
040076	SVT2301414	2300x140x140	6,80	8	715	270,00
040080	SVT7017514	700x175x140	2,45	10	255	149,00
040082	SVT9017514	900x175x140	3,30	10	345	172,00
040084	SVT11017514	1100x175x140	4,10	10	430	193,00
040086	SVT13017514	1300x175x140	4,90	10	515	211,00
040088	SVT15017514	1500x175x140	5,75	10	600	234,00
040090	SVT17017514	1700x175x140	6,55	10	685	256,00
040092	SVT19017514	1900x175x140	7,40	10	775	278,00
040094	SVT21017514	2100x175x140	8,20	10	860	301,00
040096	SVT23017514	2300x175x140	9,00	10	945	323,00
810545	BOILER PER EVAPORATORE STATICO / BOILER FOR GRAVITY COILS					29,80

EVAPORATORI STATICI PER ARMADIO / REACH-IN COOLER COILS

CODICE CODE	MODELLO MODEL	DIMENSIONI DIMENSIONS mm	N° TUBI NR. OF TUBES	LITRI FOR LITERS	LISTINO PRICE LIST €uro
040138	EVAR4043	400x430x105	12	600	185,00
040140	EVAR4049	400x490x105	14	700	205,00
040142	EVAR4056	400x560x105	16	800	225,00
040144	EVAR4085	400x850x105	24	1.200	314,00
040146	EVAR4099	400x990x105	28	1.400	354,00
040148	EVAR4599	450x990x105	28	1.800	375,00
040150	EVAR5099	500x990x105	28	2.000	393,00
040152	BACINELLA X ARMADIO				75,00



CONDENSATORI AD ACQUA

WATER EXCHANGERS

CONDENSATORI CONTROCORRENTE / COAXIAL EXCHANGERS

CODICE CODE	MODELLO MODEL	DIMENSIONI DIMENSIONS mm	POT. SUGGERITA POWER SUGGESTED HP	LISTINO PRICE LIST
040310	WC04SP	290x130x100H	0,33	167,00
040312	WC06SP	290x130x130H	0,50	240,00
040314	WC08SP	290x130x165H	0,75	312,00
040316	WC10SP	290x130x100H	1,00	389,00



CONDENSATORI ERMETICI VERTICALI / HERMETIC VERTICAL EXCHANGERS

CV3	CV3	DIAM. 120X265H	CAP. KW. 2,8* / 2,7**	473,80
CV5	CV5	DIAM. 120X265H	CAP. KW. 5,3* / 2,8**	489,30
CV10	CV10	DIAM. 120X295H	CAP. KW. 10,5* / 5,6**	702,50

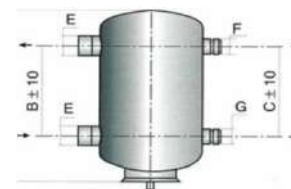

*= ACQUA DI POZZO / CITY WATER **= ACQUA DI TORRE / COOLING TOWER WATER

EVAPORATORI STATICI

GRAVITY COILS

EVAPORATORI STATICI PER CELLA - P.A. 16mm

COLD ROOM GRAVITY COILS - FIN SPACING 16mm

CODICE CODE	MODELLO MODEL	DIMENSIONI DIMENSIONS mm	SUPERF. SURFACE mq	LISTINO PRICE LIST €uro
040156	EC10040	1000x400x140	6,00	250,00
040158	EC11040	1100x400x140	6,80	268,00
040160	EC13040	1300x400x140	8,20	303,00
040162	EC15040	1500x400x140	9,60	339,00
040164	EC17040	1700x400x140	11,00	373,00
040168	EC10060	1000x600x140	9,50	354,00
040170	EC11060	1100x600x140	10,60	380,00
040172	EC13060	1300x600x140	12,80	432,00
040174	EC15060	1500x600x140	15,00	485,00
040176	EC17060	1700x600x140	17,20	535,00
040178	EC19060	1900x600x140	19,40	592,00
040180	EC21060	2100x600x140	21,60	640,00
040182	EC23060	2300x600x140	23,60	693,00
040184	EC25060	2500x600x140	25,60	745,00
040188	EC10080	1000x800x140	12,20	476,00
040190	EC11080	1100x800x140	13,60	497,00
040192	EC13080	1300x800x140	16,40	566,00
040194	EC15080	1500x800x140	19,20	636,00
040196	EC17080	1700x800x140	22,00	706,00
040198	EC19080	1900x800x140	25,00	775,00
040200	EC21080	2100x800x140	27,80	846,00
040202	EC23080	2300x800x140	30,80	915,00
040204	EC25080	2500x800x140	33,80	985,00
040206	EC130100	1300x1000x140	21,00	701,00
040208	EC150100	1500x1000x140	24,60	790,00
040210	EC170100	1700x1000x140	28,20	878,00
040212	EC190100	1900x1000x140	31,90	966,00
040214	EC210100	2100x1000x140	35,50	1.055,00
040216	EC230100	2300x1000x140	39,00	1.143,00
040218	EC250100	2500x1000x140	42,50	1.232,00
040220	EC270100	2700x1000x140	46,00	1.321,00
040222	EC300100	3000x1000x140	49,70	1.453,00

GOCCIOLATOI A PARETE E SOFFITTO

WALL AND CEILING DRAIN-PAN

CODICE CODE	MODELLO MODEL	LISTINO PRICE LIST €uro	CODICE CODE	MODELLO MODEL	LISTINO PRICE LIST €uro	CODICE CODE	MODELLO MODEL	LISTINO PRICE LIST €uro
PARETE / Wall			SOFFITTO / Ceiling					
040226	CN0100	80,00	040250	CNS10040	119,00			
040228	CN0110	82,00	040252	CNS11040	126,00			
040230	CN0130	86,00	040249	CNS13040	140,00			
040232	CN0150	90,00	040251	CNS15040	155,00			
040234	CN0170	96,00	040253	CNS17040	169,00			
040226	CN0100	80,00	040256	CNS10060	156,00			
040228	CN0110	82,00	040258	CNS11060	166,00			
040230	CN0130	86,00	040260	CNS13060	187,00			
040232	CN0150	90,00	040262	CNS15060	209,00			
040234	CN0170	96,00	040264	CNS17060	230,00			
040236	CN0190	100,00	040266	CNS19060	248,00			
040238	CN0210	104,00	040268	CNS21060	266,00			
040240	CN0230	109,00	040270	CNS23060	284,00			
040242	CN0250	114,00	040272	CNS25060	302,00			
040226	CN0100	80,00	040276	CNS10080	196,00			
040228	CN0110	82,00	040278	CNS11080	210,00			
040230	CN0130	86,00	040280	CNS13080	238,00			
040232	CN0150	90,00	040282	CNS15080	266,00			
040234	CN0170	96,00	040284	CNS17080	290,00			
040236	CN0190	100,00	040286	CNS19080	312,00			
040238	CN0210	104,00	040288	CNS21080	334,00			
040240	CN0230	109,00	040290	CNS23080	356,00			
040242	CN0250	114,00	040292	CNS25080	378,00			
040230	CN0130	86,00	040279	CNS130100	287,00			
040232	CN0150	90,00	040281	CNS150100	315,00			
040234	CN0170	96,00	040283	CNS170100	341,00			
040236	CN0190	100,00	040285	CNS190100	366,00			
040238	CN0210	104,00	040287	CNS210100	392,00			
040240	CN0230	109,00	040289	CNS230100	418,00			
040242	CN0250	114,00	040291	CNS250100	444,00			
040244	CN0270	118,00	040293	CNS270100	470,00			
040246	CN0300	142,00	040295	CNS300100	509,00			

DIMENSIONI E N° DI TUBI / DIMENSIONS AND NR. OF TUBES

- H 400 x SP.140 mm = 8 TUBI / TUBES
- H 600 x SP.140 mm = 12 TUBI / TUBES
- H 800 x SP.140 mm = 16 TUBI / TUBES
- H 1000 x SP.140 mm = 20 TUBI / TUBES

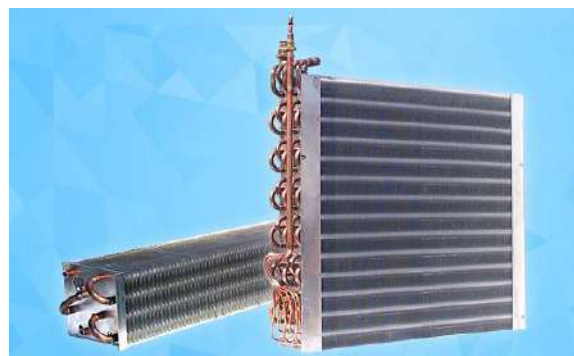

DISPONIBILI SU RICHIESTA MISURE DIFFERENTI / AVAILABLE ON REQUEST DIFFERENT SIZES

SCAMBIATORI DI CALORE A PIASTRE SALDOBRASATE

PLATE HEAT EXCHANGERS

SCAMBIATORI DI CALORE A PIASTRE

PLATE HEAT EXCHANGERS



CODICE CODE	MODELLO MODEL	DIMENSIONI DIMENSIONS mm H x L x P	ATTACCHI CONNECTIONS GAS/ODF	RESA * CAPACITY kW/cond.	ΔP H ₂ O kPa	RESA ** CAPACITY kW/evap.	ΔP H ₂ O kPa	LISTINO PRICE LIST €uro
035164	GBS 22-10	325x89x30	3/4"/22mm	3,10	0,90	-	-	312,00
035166	GBS 22-14	325x89x39,2	3/4"/22mm	4,25	0,90	1,50	1,00	358,00
035168	GBS 22-20	325x89x53	3/4"/22mm	6,00	0,90	3,00	2,00	428,00
035170	GBS 22-24	325x89x62,2	3/4"/22mm	9,00	1,40	4,00	2,40	473,00
035171	GBS 22-30	325x89x76	3/4"/22mm	12,00	1,60	4,80	2,30	544,00
035173	GBS 22-40	325x89x99	3/4"/22mm	16,00	1,60	7,50	3,20	660,00
035174	GBS 24-20	461x89x58,4	3/4"/22mm	25,00	18,30	7,50	15,40	526,00
035178	GBS 24-30	461x89x81,4	3/4"/22mm	42,00	23,60	10,50	14,00	696,00
035179	GBS 5-14	529x124x39,9	1"/35mm	21,00	16,80	7,50	19,70	586,00
035180	GBS 5-20	529x124x54	1"/35mm	34,00	21,50	10,50	19,10	706,00
035182	GBS 5-24	529x124x63,4	1"/35mm	42,00	22,80	13,50	21,90	786,00
035184	GBS 5-30	529x124x77,5	1"/35mm	58,00	27,80	16,00	20,00	906,00
035186	GBS 5-34	529x124x86,9	1"/35mm	70,00	31,60	20,00	24,20	986,00
035188	GBS 5-40	529x124x101	1"/35mm	82,00	31,80	25,00	27,50	1.106,00
035189	GBS 5-44	529x124x110,4	1"/35mm	93,00	34,00	-	-	1.186,00
035190	GBS 5-50	529x124x124,5	1"/35mm	105,00	34,20	29,00	24,50	1.306,00
035191	GBS 5-60	529x124x148	1"/35mm	125,00	34,80	35,00	25,50	1.505,00

* RESA / CAPACITY R22: Temp. Cond. +35°C, H₂O +15...+30°C

** RESA / CAPACITY R22: Temp. Evap. +2°C, surr.5K, H₂O +12...+7°C

BATTERIE CONDENSANTI

CONDENSER COILS

CONDENSATORI AD ARIA COMPLETI DI VENTILATORI

AIR-COOLED CONDENSERS WITH FAN MOTORS

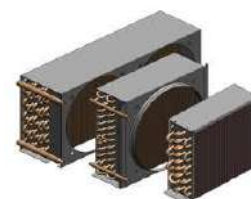

CODICE CODE	MODELLO MODEL	DIMENSIONI DIMENSIONS mm	N. TUBI Tubes Nr.	P.ARIA AIR FLOW m3/h	RESA CAPACITY WATT DT15	VENTIL. FANS	LISTINO PRICE LIST €uro
035148	1130270FEORV	326x139x282h	28	690	1.220	1x254	170,40
035150	1140270FE1RV	326x147x282h	44	626	1.450	1x254	189,70
035152	1140270FE71RV	326x147x282h	44	626	1.540	1x254	214,30
035154	1340325CE1	385X170X330h	48	838	2.030	1x300	323,60
035159	CEV4225	680X262X320	-	1.480	5.000	2X250	434,00

CONDENSATORI AD ARIA SENZA VENTILATORI

AIR-COOLED CONDENSERS WITHOUT FAN MOTORS

VENTILAT. CONS.
FAN SUGGESTED

035158	CEV4230	780X180X370H		2.500	7.440	2x300	532,00
035161	CEV5235	985X200X420H		3.920	13.000	2x350	810,00
035162	CEV5241	1190X200X520H		5.400	18.200	2x400	1.294,00
035155	CEV5245	1358X210X635H		9.900	25.200	2x450	1.600,00

MINICELLE FRIGORIFERE

MINI COLD-ROOMS

MINICELLE FRIGORIFERE - TEMPERATURA POSITIVA TN - SPESS.60MM

MINI COLD-ROOMS - NORMAL TEMPERATURE NT - THICKNESS 70MM

PREZZI NETTI - PREZZI NETTI - PREZZI NETTI - PREZZI NETTI - PREZZI NETTI

MODELLO MODEL	DIM. EST. EXT. DIM. cm	VOL.INT INT. VOL. m3	con PAV. with floor Euro	senza PAV. without floor Euro
TN288	1340x1340x2140h	2,88	1740,00	1591,00
TN336	1340x1540x2140h	3,36	1848,00	1688,00
TN384	1340x1740x2140h	3,84	1949,00	1773,00
TN432	1340x1940x2140h	4,32	2009,00	1824,00
TN480	1340x2140x2140h	4,80	2066,00	1865,00
TN392	1540x1540x2140h	3,92	2026,00	1817,00
TN448	1540x1740x2140h	4,48	2126,00	1901,00
TN504	1540x1940x2140h	5,04	2194,00	1957,00
TN560	1540x2140x2140h	5,60	2251,00	1998,00
TN512	1740x1740x2140h	5,12	2231,00	1989,00
TN640	1740x2140x2140h	6,40	2363,00	2086,00
TN648	1740x2540x2140h	7,68	2539,00	2231,00
TN896	1740x2940x2140h	8,96	2716,00	2375,00
TN648	1940x1940x2140h	6,48	2375,00	2102,00
TN792	1940x2340x2140h	7,92	2535,00	2226,00
TN864	1940x2540x2140h	8,64	2623,00	2295,00
TN1008	1940x2940x2140h	10,08	2808,00	2443,00



MINICELLE FRIGORIFERE - BASSA TEMPERATURA BT - SPESS.100MM -

MINI COLD-ROOMS - LOW TEMPERATURE LT - THICKNESS 100MM -

MODELLO MODEL	DIM. EST. EXT. DIM. cm	VOL.INT INT. VOL. m3	con PAV. with floor Euro	senza PAV. without floor Euro
BT288	1430X1430X2230H	2,88	2322,00	-
BT336	1430X1630X2230H	3,36	2451,00	-
BT384	1430X1830X2230H	3,84	2567,00	-
BT432	1430X2030X2230H	4,32	2653,00	-
BT392	1630X1630X2230H	3,92	2649,00	-
BT448	1630X1830X2230H	4,48	2772,00	-
BT504	1630X2030X2230H	5,04	2861,00	-
BT560	1630X2230X2230H	5,60	2940,00	-
BT704	1830X2430X2230H	7,04	3218,00	-
BT768	1830X2630X2230H	7,68	3334,00	-
BT792	2030X2430X2230H	7,92	3323,00	-
BT936	2030X2830X2230H	9,36	3591,00	-
BT1008	2030X3030X2230H	10,08	3816,00	-



PREZZI NETTI - PREZZI NETTI - PREZZI NETTI - PREZZI NETTI - PREZZI NETTI

PROFILO SANITARIO IN PVC 45° - SISTEMA DI AGGANCIO CON GANCI ECCENTRICI

PANNELLATURA DA 60mm. (TN) 100 mm. (BT)

PORTA CUN LUCE DA 80X180(190) mm.

ACCESSORI PER CELLE FRIGORIFERE / MINI COLD ROOMS ACCESSORIES

		LISTINO PRICE LIST
MICROELEBAR	VALVOLA COMPENSAZIONE A SIGARETTA	29,90
MINIELEBAR	MINI- VALVOLA COMPENSAZIONE	68,50
ELEBAR	VALVOLA COMPENSAZIONE	97,30
MANIGLIA 1825	MANIGLIA MODELLO 1825	125,50
MANIGLIA PANNELLI	MANIGLIA STANDARD MTH	243,30
MICROPORTA	MICRO PORTA PIZZATO FR530	28,90

MONOBLOCCHI RIVACOLD PER CELLE FRIGORIFERE

RIVACOLD MONOBLOCK UNITS FOR COLD-ROOMS

MONOBLOCCHI BLOKSYSTEM "FA/FT" R134A

"FA/FT" BLOKSYSTEM MONOBLOCK UNITS R134A FOR COLD ROOMS



FA: ACCAVALLATO - FT: TAMPONE --FA: SADDLE VERSION - FT: PLUG IN VERSION

MODELLO MODEL	TENSIONE VOLTAGE	POT. NOM. HP	RESA FRIG. CAPACITY Watt	VOL.CELLA C.ROOM VOL. mc	CONDENS. CONDENSER Nr.vent. x diam.	EVAPORAT. EVAPORAT. Nr.vent. x diam.	LISTINO PRICE LIST €uro
			TC 0°C	TA +32°C			
FA/FTM003Y001	230/1/50	0,50	787	4,2	1x254mm	1x200mm	2.526,00
FA/FTM006Y001	230/1/50	1,00	885	5,1	1x254mm	1x200mm	2.591,00
FA/FTM009Y001	230/1/50	1,20	1.037	6,7	1x254mm	1x200mm	2.888,00
FA/FTM012Y001	230/1/50	1,25	1.206	8,7	1x254mm	1x200mm	3.044,00
FA/FTM016Y001	230/1/50	1,50	1.830	15,0	1x300mm	2x200mm	3.570,00
FA/FTM022Y002	400/3/50	1,50	2.205	19,4	1x300mm	2x200mm	3.884,00
FA/FTM040Y002	400/3/50	2,00	3.437	38,4	1x350mm	1x350mm	5.104,00

MONOBLOCCHI BLOKSYSTEM "FA/FT" R452A

"FA/FT" BLOKSYSTEM MONOBLOCK UNITS R452A FOR COLD ROOMS

FA: ACCAVALLATO - FT: TAMPONE --FA: SADDLE VERSION - FT: PLUG IN VERSION

MODELLO MODEL	TENSIONE VOLTAGE	RESA FRIG. CAPACITY Watt	VOL.CELLA C.ROOM VOL. mc	CONDENS. CONDENSER Nr.vent. x diam.	EVAPORAT. EVAPORAT. Nr.vent. x diam.	LISTINO PRICE LIST €uro
		TC 0°C	TA +32°C			
FA/FTM003G001	230/1/50	821	4,60	1x254mm	1x200mm	2.450,00
FA/FTM006G001	230/1/50	975	6,00	1x254mm	1x200mm	2.512,00
FA/FTM007G001	230/1/50	1.146	7,90	1x254mm	1x200mm	2.704,00
FA/FTM009G001	230/1/50	1.302	10,60	1x254mm	1x200mm	2.802,00
FA/FTM012G001	230/1/50	1.420	11,10	1x254mm	1x200mm	2.954,00
FA/FTM016G001	230/1/50	1.960	16,40	1x300mm	2x200mm	3.459,00
FA/FTM022G002	400/3/50	2.234	19,80	1x300mm	2x200mm	3.855,00
FA/FTM028G002	400/3/50	2.526	23,90	1x300mm	2x200mm	3.979,00
FA/FTM034G002	400/3/50	2.995	31,10	1x350mm	1x350mm	4.597,00
FA/FTM040G002	400/3/50	3.389	37,60	1x350mm	1x350mm	4.950,00
		TC -20°C	TA +32°C			
FA/FTL003G011	230/1/50	671	3,60	1x254mm	1x200mm	2.944,00
FA/FTL006G011	230/1/50	817	4,80	1x254mm	1x200mm	3.202,00
FA/FTL009G011	230/1/50	953	6,10	1x254mm	1x200mm	3.234,00
FA/FTL012G011	230/1/50	1.266	11,10	1x300mm	2x200mm	3.499,00
FA/FTL016G012	400/3/50	1.577	16,30	1x300mm	2x200mm	4.259,00
FA/FTL020G012	400/3/50	1.914	19,40	1x350mm	1x350mm	5.239,00
FA/FTL024G012	400/3/50	2.343	29,20	1x350mm	1x350mm	5.239,00
FA/FTL034G012	400/3/50	2.547	34,20	1x350mm	1x350mm	6.142,00



CARATTERISTICHE GENERALI GENERAL FEATURES

- CENTRALINA ELETTRONICA DI CONTROLLO / *electronic control panel*
- INTERRUTTORE GENERALE (ON-OFF) / *general on/off switch*
- INTERRUTTORE LUCE CELLA / *cold-room light switch*
- LUCE CELLA CON CAVO L=2,5m / *cold-room light with 2,5m long cable*
- MICRO PORTA CON CAVO L=2,5m / *door micro switch with 2,5m long cable*
- CAVO RESISTENZA PORTA NEI MODELLI BT / *door heater cable for BT models*
- PRESSOSTATO DI ALTA / *high pressure switch*
- BACINELLA EVAPORAZIONE ACQUA CONDENSA / *evaporating water tray*



FILTRI DEIDRATORI GMC

GMC FILTER DRIERS

FILTRI A CARTUCCIA COMPATTA

DI SETACCIO MOLECOLARE

MOLECULAR SOLID CORE FILTER DRIERS



CODICE CODE	MODELLO MODEL	ATTACCHI CONNECT.	CAPACITA'	CAPACITA'	CAPACITA'	CC CC	DIMENS. DIMENS. L x diam. mm	LISTINO PRICE LIST Euro
			CAPACITY kW R22/R407C	CAPACITY kW R134a	CAPACITY kW R404A			
380100	SC032MM	1/4"SAE	6,2	6,0	4,0	50	103x57,5	14,10
380102	SC032MF	1/4"SAE MF	6,2	6,0	4,0	50	93x57,5	14,10
380104	SC033MM	3/8"SAE	19,0	17,0	13,0	50	111x57,5	14,10
380106	SC052MM	1/4"SAE	7,0	6,6	4,4	80	116x57,5	16,20
380108	SC053MM	3/8"SAE	19,0	18,0	14,0	80	124x57,5	16,20
380110	SC082MM	1/4"SAE	8,0	7,0	5,0	130	141x57,5	17,80
380112	SC083MM	3/8"SAE	20,0	18,5	13,0	130	149x57,5	18,90
380114	SC083MF	3/8"SAE MF	20,0	18,5	13,0	130	137x57,5	18,90
380116	SC084MM	1/2"SAE	29,0	26,0	20,0	130	157x57,5	19,30
380118	SC162MM	1/4"SAE	8,0	7,0	5,0	250	154x77,5	24,10
380120	SC163MM	3/8"SAE	24,0	22,0	16,0	250	162x77,5	24,90
380122	SC164MM	1/2"SAE	36,0	34,0	24,0	250	170x77,5	25,20
380124	SC165MM	5/8"SAE	43,0	40,0	28,0	250	179x77,5	28,00

FILTRI A CARTUCCIA SOLIDA ANTIACIDO

ANTIACID SOLID CORE FILTER DRIERS

380040	SCA032S	1/4"ODF	10,0	8,5	7,0	50	95x57,5	14,10
380043	SCA052S	1/4"ODF	11,0	9,0	7,5	80	107x57,5	16,60
380046	SCA082S	1/4"ODF	12,0	10,5	9,0	130	132x57,5	20,00
380048	SCA083M10S	10mm ODF	27,0	25,0	17,0	130	134x57,5	20,00
380050	SCA084M12S	12mm ODF	36,0	33,0	23,0	130	141x57,5	20,00
380051	SCA162S	1/4"ODF	14,0	11,0	9,5	250	145x77,5	26,20
380053	SCA163M10S	10mm ODF	31,0	29,0	20,0	250	147x77,5	26,20
380055	SCA164M12S	12mm ODF	41,0	39,0	31,0	250	154x77,5	26,20
380056	SCA165S	5/8"ODF	54,0	50,0	35,0	250	162x77,5	30,50
380057	SCA324S	1/2"ODF	50,0	48,0	40,0	500	187x93	48,30
380058	SCA325S	5/8"ODF	57,0	55,0	42,0	500	195x93	48,30
380059	SCA414S	1/2"ODF	52,0	50,0	42,0	670	218x93	74,90
380060	SCA415S	5/8"ODF	59,0	57,0	44,0	670	226x93	74,90
380061	SCA416S	3/4"ODF	75,0	70,0	48,0	670	231x93	74,90
380062	SCA417S	7/8"ODF	83,0	78,0	54,0	670	231x93	74,90

FILTRI A CARTUCCIA SOLIDA ANTIACIDO COMPLETI DI INDICATORE DI LIQUIDO

ANTIACID SOLID CORE FILTER DRIERS WITH SIGHT-GLASS

380142	SCMI082	1/4"SAE						45,70
380144	SCMI083	3/8"SAE						47,20
380141	SCMI052S	1/4"ODF						41,10
380143	SCMI053M10S	10mm ODF						41,10
380145	SCMI083M10S	10mm ODF						51,10



FILTRI DEIDRATORI GMC

GMC FILTER DRIERS

FILTRI A CARTUCCIA SOLIDA ANTIACIDO

ANTIACID SOLID CORE FILTER DRIERS



CODICE CODE	MODELLO MODEL	ATTACCHI CONNECT.	CAPACITA' CAPACITY kW R407C	CAPACITA' CAPACITY kW R134a	CAPACITA' CAPACITY kW R404A	CC CC	DIMENS. DIMENS. L x diam. mm	LISTINO PRICE LIST Euro
380000	SCA032MM	1/4"SAE	10,0	8,5	7,0	50	103x57,5	14,10
380002	SCA032MF	1/4"SAE MF	10,0	8,5	7,0	50	93x57,5	14,10
380003	SCA033MM	3/8"SAE	19,5	17,5	13,5	50	111x57,5	14,10
380004	SCA052MM	1/4"SAE	11,0	9,0	7,5	80	116x57,5	16,60
380005	SCA052MF	1/4"SAE MF	11,0	9,0	7,5	80	108x57,5	16,60
380006	SCA053MM	3/8"SAE	23,0	21,0	16,0	80	124x57,5	16,60
380010	SCA082MM	1/4"SAE	12,0	10,5	9,0	130	141x57,5	20,00
380012	SCA083MM	3/8"SAE	27,0	25,0	17,0	130	149x57,5	20,00
380014	SCA083MF	3/8"SAE MF	27,0	25,0	17,0	130	137x57,5	20,00
380016	SCA084MM	1/2"SAE	36,0	33,0	23,0	130	157x57,5	20,00
380018	SCA162MM	1/4"SAE	14,0	11,0	9,5	250	154x77,5	26,20
380020	SCA163MM	3/8"SAE	31,0	29,0	20,0	250	162x77,5	26,20
380022	SCA164MM	1/2"SAE	41,0	39,0	31,0	250	170x77,5	26,20
380024	SCA165MM	5/8"SAE	54,0	50,0	35,0	250	179x77,5	30,50
380026	SCA324MM	1/2"SAE	50,0	48,0	40,0	500	203x93	48,30
380028	SCA325MM	5/8"SAE	57,0	55,0	42,0	500	212x93	48,30
380030	SCA414MM	1/2"SAE	52,0	50,0	42,0	670	234x93	74,90
380032	SCA415MM	5/8"SAE	59,0	57,0	44,0	670	243x93	74,90
380034	SCA416MM	3/4"SAE	75,0	70,0	48,0	670	245x93	74,90

INDICATORI DI LIQUIDO E UMIDITA' GMC

GMC MOISTURE AND LIQUID INDICATORS

CODICE CODE	MODELLO MODEL	ATTACCHI CONNECT.	TIPO TYPE	DIMENS. DIMENS. L x H mm	LISTINO PRICE LIST Euro	
380201	MI2MF	1/4"SAE	M x F		70x29,5	19,80
380203	MI3MF	3/8"SAE	M x F		75x29,5	23,50
380205	MI4MF	1/2"SAE	M x F		80x31,5	24,70
380207	MI5MF	5/8"SAE	M x F		85x35,5	34,80
380209	MI6MF	3/4"SAE	M x F		94x41,5	56,30
380200	MI2MM	1/4"SAE	M x M		70x22,5	18,20
380202	MI3MM	3/8"SAE	M x M		75x29,5	19,80
380204	MI4MM	1/2"SAE	M x M		80x29,5	23,50
380206	MI5MM	5/8"SAE	M x M		88x31,5	24,70
380208	MI6MM	3/4"SAE	M x M		91x35,5	34,80
380210	MI2S	1/4"ODS	sald. / solder		125x22,5	24,70
380212	MI3S	3/8"ODS	sald. / solder		125x22,5	27,00
380214	MIM10S	10mm ODS	sald. / solder		125x22,5	27,00
380216	MIM12S	12mm ODS	sald. / solder		132x29,5	29,30
380218	MI4S	1/2"ODS	sald. / solder		132x29,5	29,30
380220	MI5S	5/8"ODS	sald. / solder		145x29,5	30,90
380222	MIM18S	18mm ODS	sald. / solder		145x31,5	37,80
380224	MI6S	3/4"ODS	sald. / solder		145x31,5	37,80
380226	MI7S	7/8"ODS	sald. / solder		155x35,5	58,60
380228	MI9S	1.1/8"ODS	sald. / solder		183x41,5	69,10

VALVOLE SOLENOIDI GMC PER FLUIDI FRIGORIGENI SENZA BOBINA

GMC SOLENOID VALVES FOR ALL REFRIGERANTS WITHOUT COIL

CODICE CODE	MODELLO MODEL	ATTACCHI CONNECTIONS	ORIFIZIO ORIFICE	MOPD * BAR *	LISTINO PRICE LIST Euro
380500	EVR32MM	1/4"SAE	3,3	25	26,50
380505	EVR33MM	3/8"SAE	3,3	25	29,70
380523	EV103MM	3/8"SAE	10	25	45,30
380525	EV104MM	1/2"SAE	10	25	55,60
380527	EV125MM	5/8"SAE	12	25	
380501	EVR32S	1/4"ODS	3,3	25	29,70
380521	EVR3M10S	10mm ODS	3,3	25	33,40
380529	EV10M10S	10mm ODS	10	25	50,70
380531	EV10M12S	12mm ODS	10	25	63,10
380533	EV125S	5/8"ODS	12	25	73,30
380535	EV226S	3/4"ODS	22	25	122,80
380537	EV227S	7/8"ODS	22	25	122,80



VALVOLE SOLENOIDI CASTEL PER FLUIDI FRIGORIGENI SENZA BOBINA

CASTEL SOLENOID VALVES FOR ALL REFRIGERANTS WITHOUT COIL

CODICE CODE	MODELLO MODEL	ATTACCHI CONNECTIONS SAE-flare	ORIFIZIO ORIFICE	MOPD * BAR *	LISTINO PRICE LIST Euro
110200	1020/2S	1/4"	2,5	21	30,80
110205	1020/3S	3/8"	3,0	18	34,00
110210	1064/3S	3/8"	7,0	21	48,90
110215	1064/4S	1/2"	7,0	21	48,90
110220	1070/4S	1/2"	12,5	21	60,60
110225	1070/5S	5/8"	12,5	21	89,20



CODICE CODE	MODELLO MODEL	ATTACCHI CONNECTIONS ODS solder	ORIFIZIO ORIFICE	MOPD * BAR *	LISTINO PRICE LIST Euro
110201	1028/2S	1/4"	2,2	21	34,00
110221	1068/M10S	10mm	7,0	21	53,10
110226	1068/M12S	12mm	7,0	21	55,30
110236	1078/M12S	12mm	12,5	21	69,10
110246	1078/5S	5/8" / 16mm	12,5	21	89,20
110251	1098/6S	3/4"ods	17,0	21	129,50
110261	1098/7S	7/8" / 22mm	17,0	21	149,70
110266	1098/9S	1.1/8"	17,0	21	379,90



BOBINE E CONNETTORI / COILS AND IP65 ELECTRIC CONNECTORS

CODICE CODE	MODELLO MODEL	TENSIONE VOLTAGE	PRODOTTO PRODUCT	LISTINO PRICE LIST Euro
380514	KMA6	220/230V	GMC	
380504	KMA2	24/50V	GMC	
110204	HM2-9100/RA2	24V-50/60Hz	CASTEL	16,00
110209	HM2-9100/RA4	110V-50/60Hz	CASTEL	16,00
110214	HM2-9100/RA6	220V-50/60Hz	CASTEL	16,00
703131	MAS20	sblocca bobine magnetico per elettrovalvole		63,80
380515	JB 100	CONNETTORE ELETTRICO C/CAVO MT.1 / 1 MT. CABLE ELECTRIC CONNECTOR		7,30
110229	9150/R02	CONNETTORE ELETTRICO / ELECTRIC CONNECTOR		4,40



FILTRI DEIDRATORI GMC

GMC FILTER DRIERS

FILTRI A CARTUCCIA SOLIDA ANTIACIDO INTERCAMBIABILE

FILTER DRIERS WITH REPLACEABLE SOLID CORES



CODICE CODE	MODELLO MODEL	ATTACCHI CONNECT. ODS	N° CARTUCCE Nr. OF CORES	CUBAT. NOM. NOM. VOL. CC	DIMENSIONI DIMENSIONS L x diam. mm	LISTINO PRICE LIST Euro
380160	CSR485	5/8" / 16mm	1	800	234x154	175,40
380161	CSR487	7/8" / 22mm	1	800	239x154	175,40
380162	CSR489	1.1/8"	1	800	244x154	180,10
380163	CSR4811	1.3/8" / 35mm	1	800	244x154	180,10
380164	CSR4813	1.5/8"	1	800	249x154	192,80
380165	CSR48M42	42mm	1	800	249x154	192,80
380166	CSR4817	2.1/8" / 54mm	1	800	261x154	192,80
380167	CSR4821	2.5/8"	1	800	261x154	225,90
380168	CSR967	7/8" / 22mm	2	1.600	381x154	210,60
380169	CSR969	1.1/8"	2	1.600	386x154	210,50
380170	CSR9611	1.3/8" / 35mm	2	1.600	386x154	215,40
380171	CSR96M42	42mm	2	1.600	389x154	225,90
380172	CSR9617	2.1/8" / 54mm	2	1.600	403x154	225,90
380173	CSR14411	1.3/8" / 35mm	3	2.400	528x154	249,20
380174	CSR14413	1.5/8"	3	2.400	533x154	253,90
380175	CSR144M42	42mm	3	2.400	533x154	253,90
380176	CSR19213	1.5/8"	4	3.200	675x154	286,90
380177	CSR192M42	42mm	4	3.200	675x154	286,90
380178	CSR19217	2.1/8" / 54mm	4	3.200	686x154	286,90

CARTUCCE DEIDRATANTI

SOLID CORES

CARTUCCE SOLIDE PER FILTRI RICARICABILI / REPLACEABLE FILTER DRIER SOLID CORES

380150	CSR48	cartuccia solida 100% setacci molecolari / <i>replaceable filter drier solid core 100% molecular sieves high water adsorption capacity</i>	25,10
380152	CSR48A	cartuccia solida a setacci molecolari a allumina attiva-antiacidi / <i>replaceable filter drier solid core with molecular sieves and activated alumina</i>	32,50
380154	MFC48	cartuccia meccanica / <i>mechanical cartridge</i>	45,30
122032	H48	cartuccia solida deidratrice Alco / <i>Alco dehydrating solid core</i>	36,10
122034	W48	cartuccia solida antiacido Alco / <i>Alco antiacid solid core</i>	69,90



RICEVITORI DI LIQUIDO VERTICALI CERTIFICATI PED

VERTICAL LIQUID RECEIVERS PED APPROVED

CODICE CODE	MODELLO MODEL	ATTACCHI CONNECTIONS	CAP. CAP. lt.	ATT. X SICUR. FUSE PLUG CONN.	PESCANTE INT. SUCT. TUBE	LISTINO PRICE LIST Euro
810750P	077/220VS00	6,2 x 6,2mm	0,9	no	no	38,30
810752P	100/200VS00	8,2 x 6,2mm	1,3	no	no	51,00
120182VR02	120/182VR02	10mm x 1"-14unf	1,7	no	si	76,50
810754P	A120X250	10mm x 1"-14unf	2,4	si 1/4"NPT	si	64,80
810756P	A130X310	10mm x 1"-14unf	3,4	si 1/4"NPT	si	81,80
810758	A160X345	12mm x 1"-14unf	5,7	si 1/4"NPT	si	96,50
810760	A220X365	12mm x 1"-1/4unf	11,0	si 1/4"NPT	si	196,10

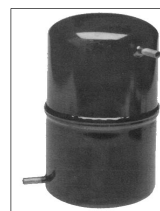

ELIMINATORI DI VIBRAZIONI

VIBRATION ELIMINATORS

CODICE CODE	MODELLO MODEL	ATTACCHI CONNECTIONS	LUNGHEZZA LENGTH	LISTINO PRICE LIST Euro
		mm	mm	
810814	VTIG-10	10	230	25,30
810818	VTIG-12	12	230	26,40
810822	VTIG-16	16	255	29,50
810826	VTIG-18	18	255	33,70
810830	VTIG-22	22	290	42,10
810834	VTIG-28	28	330	55,70
810838	VTIG-35	35	375	79,90
810842	VTIG-42	42	430	116,70
810846	VTIG-54	54	510	168,10



SILENZIATORI E SEPARATORI DI LIQUIDO / OLIO

MUFLERS, SUCTION ACCUMULATORS AND OIL SEPARATORS

SILENZIATORI / MUFLERS

CODICE CODE	MODELLO MODEL	ATTACCHI CONNECTIONS	DIMENSIONI DIMENSIONS	CAPACITA' capacity	LISTINO PRICE LIST Euro
		mm	mm	lt	
810801	STL-76/12	12 mm.	82x192	0,53	91,40
810803	STL-76/16	16 mm.	82x195	0,53	98,30
810805	STL-76/22	22 mm.	82x248	0,65	101,20
810807	STL-76/28	28 mm.	82x248	0,65	103,50
810809	STL-100/35	35 mm.	106X350	1,6	163,70



SEPARATORI DI LIQUIDO / SUCTION ACCUMULATORS

CODICE CODE	MODELLO MODEL	ATTACCHI CONNECTIONS	DIMENSIONI DIMENSIONS	LISTINO PRICE LIST Euro
		mm	mm	
810817	SL05/S-22	22 ODS	130X355H	112,10
810821	SL07/S-28	28 ODS	160X385H	158,60
810825	SL08/S-35	35 ODS	180X430H	222,80
810829	SL10/S-42	42 ODS	260X495H	338,70
810833	SL11/S-54	54 ODS	280X550H	436,30



SEPARATORI DI OLIO / OIL SEPARATORS

810713	SO/ERS12100	12mm	101,6X289H	1,5	241,80
810715	SO/ERS16100	16mm	101,6X329H	1,8	258,40
810717	SO/ERS22100	22mm	101,6X340H	1,8	266,90
810719	SO/ERS28100	28mm	101,6X392H	2,2	290,50

VALVOLE SOLENOIDI CASTEL PER ACQUA E ARIA SENZA BOBINA

CASTEL SOLENOID VALVES FOR WATER AND AIR WITHOUT COIL

ATTACCHI FPT GAS FEMMINA / FPT FEMALE CONNECTIONS

CODICE CODE	MODELLO MODEL	ATTACCHI CONNECTIONS FPT-flare	ORIFIZIO ORIFICE	BOBINA COIL	MOPD * BAR *	LISTINO PRICE LIST €uro
110202	1132/03S	3/8"FPT	12,5	HM	17,0	65,90
110207	1132/04S	1/2"FPT	12,5	HM	17,0	65,90
110212	1132/06S	3/4"FPT	20,0	HM	12,0	118,90

BOBINE E CONNETTORI / COILS AND IP65 ELECTRIC CONNECTORS

CODICE CODE	MODELLO MODEL	TENSIONE VOLTAGE	LISTINO PRICE LIST €uro
110204	HF2	24V-50/60Hz	16,00
110209	HF2	110V-50/60Hz	16,00
110214	HF2	220V-50/60Hz	16,00
110229	CONN.	CONNETTORE ELETTRICO / ELECTRIC CONNECTOR	4,40



VALVOLE REGOLAT. AUTOM. DELL'ACQUA E PRESSOSTATI DIFFERENZIALI

REGULATOR WATER VALVES & WATER SWITCH

CODICE CODE	MODELLO MODEL	ATTACCHI CONNECT.	CAMPO DI TARATURA SETTING RANGE	CASA BRAND	LISTINO PRICE LIST €uro
AWR120	AWR-1203GLW	3/8"FPT	6 / 18 BAR	SAGINOMIYA	162,20
AWR150	AWR-1504GLW	1/2"FPT	6 / 18 BAR	SAGINOMIYA	167,90
AWR200	AWR-2006GLW	3/4"FPT	6 / 18 BAR	SAGINOMIYA	216,90
AWR2510	AWR-2010GLW	1 "FPT	6 / 18 BAR	SAGINOMIYA	384,70
120929	WVFX-32 (3F1232)	1.1/4"FPT	3,5 / 16 BAR	DANFOSS	614,80
120932	WVFX-40 (3F1240)	1.1/2"FPT	3,5 / 16 BAR	DANFOSS	650,00



ACCESSORI PER VALVOLE / VALVE ACCESSORIES

900495	NSN-3	3/8"NPT		4,60
900507	NSN-4	1/2"NPT		6,60
900519	NSN-6	3/4"NPT		15,40
900614	CPL1000	1/4"SAE		9,50
900615	CPL100-dpr	1/4"SAE c/ depress.		11,90



PRESSOSTATI DIFFERENZIALI PER ACQUA TOVO /TOVO DIFFERENTIAL WATER PRESSURE SWITCH

TOVO	SFS	1/4"-3/8" npt	119,60
------	-----	---------------	--------

MINIPRESSOSTATI AUTOMATICI

AUTORESET MINI-PRESSURE SWITCH

CODICE CODE	MODELLO MODEL	CAMPO DI TARATURA SETTING RANGE BAR	LISTINO PRICE LIST €uro
121032	LCB-PA65	0,7 / 1,7	36,50
121031	ACB-PB81	23 / 28	36,50
P100-DA07D	P100-DA07D	26,0 BAR / MAN. RESET	76,10



C/CAVO

VALVOLE TERMOSTATICHE DANFOSS
 DANFOSS THERMOSTATIC EXPANSION VALVES



VALVOLE TERMOSTATICHE AD ORIFICIO INTERCAMBIABILE T/TE2
 T/TE2 THERMOSTATIC EXPANSION VALVES WITH INTERCHANGEABLE ORIFICE

CODICE CODE	MODELLO MODEL	EQUAL. EQUAL.	REFRIG REFRIG.	CAMPO RANGE °C	ATTACCHI CONNECTIONS	LISTINO PRICE LIST €uro
120050	TS2	INT.	R404A	-40/+10	3/8"x1/2"SAE	83,80
120065	TS2	INT.	R404A	-40/+10	3/8"x12mmODS	83,80
120055	TES2	EXT.	R404A	-40/+10	3/8"x1/2"SAE	140,00
120060	TES2	EXT.	R404A	-40/+10	3/8"x12mmODS	140,00
120013	TZ2	INT.	R407C	-40/+10	3/8"x1/2"SAE	83,80
120014	TZ2	INT.	R407C	-40/+10	3/8"x12mmODS	83,80
120016	TEZ2	EXT.	R407C	-40/+10	3/8"x1/2"SAE	140,00
120030	TN2	INT.	R134a	-40/+10	3/8"x1/2"SAE	83,80
120035	TN2	INT.	R134a	-40/+10	3/8"x12mmODS	83,80
120040	TEN2	EXT.	R134a	-40/+10	3/8"x1/2"SAE	140,00
120045	TEN2	EXT.	R134a	-40/+10	3/8"x12mmODS	140,00
120150	TS2- NEW	INT.	R448A/R449A	-40/+10	3/8"x12mmODS	93,80
120152	TES2- NEW	EXT.	R448A/R449A	-40/+10	3/8"x12mmODS	156,90
120154	TS2- NEW	INT.	R452A	-40/+10	3/8"x12mmODS	93,80
120156	TES2- NEW	EXT.	R452A	-40/+10	3/8"x12mmODS	156,90

ORIFICI PER VALVOLE DANFOSS T/TE2

T/TE2 DANFOSS ORIFICE ASSEMBLY

CODICE CODE	MODELLO MODEL	RESA / CAP. R404-MBP (Watt)		RESA / CAP. R404-LBP (Watt)		RESA / CAP. R134a-MBP (Watt)		RESA / CAP. R407C-MBP (Watt)		LISTINO PRICE LIST €uro
		Tc = +40°C Te = -10°C		Tc = +40°C Te = -30°C		Tc = +45°C Te = -10°C		Tc = +45°C Te = +5°C		
120100	T/TE2 0X	400		340		440		500		31,90
120105	T/TE2 00	780		640		820		1100		31,90
120110	T/TE2 01	1.460		950		1.490		2700		31,90
120115	T/TE2 02	2.070		1.280		2.110		3800		31,90
120120	T/TE2 03	3.720		2.330		3.770		5600		31,90
120125	T/TE2 04	5.490		3.480		5.550		8600		31,90
120130	T/TE2 05	6.960		4.430		7.050		11300		31,90
120140	T/TE2 06	8.510		5.420		8.610		16700		31,90

ADATTATORE A SALDARE PER VALVOLE T/TE2

T/TE2 SOLDER ADAPTOR

ATTACCHI
CONNECTIONS

ADAPTER ADATTATORE T/TE2

6 mm o/or 10 mm

31,50

ELEMENTI TERMOSTATICI PER VALVOLE TE5

THERMOSTATIC ELEMENTS FOR TE5/12/20/55 VALVES

CODICE CODE	MODELLO MODEL	EQUAL. EQUAL.	REFRIG REFRIG.	CAMPO RANGE °C	LISTINO PRICE LIST €uro
120295	TES5	EXT.	R404A	-40/+10	229,80
120285	TEN5	EXT.	R134a	-40/+10	229,80
120251	TEZ5	EXT.	R407C	-40/+10	229,80

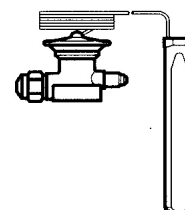

VALVOLE TERMOSTATICHE DANFOSS
DANFOSS THERMOSTATIC EXPANSION VALVES

CORPI PER VALVOLE SERIE TE5/12/20/55
BODIES FOR TE5/12/20/55 VALVES

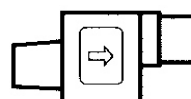
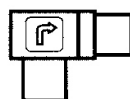

CODICE CODE	MODELLO MODEL	EQUAL. EQUAL.	ATTACCHI CONNECTIONS	DESCRIZIONE DESCRIPTIONS	LISTINO PRICE LIST
120205	TE5	EXT.	1/2"x5/8"ODS	ODS AD ANG. / ods angleway	€uro 67,60
120210	TE5	EXT.	1/2"x5/8"ODS	ODS IN LINEA / ods straightway	67,60

ORIFICI PER VALVOLE DANFOSS TE5
DANFOSS ORIFICE ASSEMBLY FOR TE5/12/20/55 VALVES

CODICE CODE	MODELLO MODEL	RESA / CAP. R404A-MBP (Watt) Tc = +40°C Te = -10°C	RESA / CAP. R404A-LBP (Watt) Tc = +40°C Te = -30°C	RESA / CAP. R134a-MBP (Watt) Tc = +45°C Te = -10°C	LISTINO PRICE LIST
120102	T/TE5 0,5	8.700	4.500	7.000	€uro 95,50
120101	T/TE5 01	12.300	7.500	10.500	95,50
120106	T/TE5 02	16.900	10.500	15.800	95,50
120111	T/TE5 03	25.200	16.200	23.500	95,50
120116	T/TE5 04	36.100	23.200	33.600	137,70



VALVOLE SOLENOIDI DANFOSS PER FLUIDI FRIGORIGENI
DANFOSS SOLENOID VALVES FOR ALL REFRIGERANTS

ATTACCHI A SALDARE / SOLDER CONNECTIONS

LISTINO
PRICE LIST

120525	EVR3	6mm	21,0	18,0	€uro 72,70
120530	EVR6	10mm	21,0	18,0	106,60
120535	EVR10	12mm	21,0	18,0	145,60
120540	EVR15	16mm	21,0	18,0	242,00
120545	EVR20	22-28-35mm	21,0	18,0	376,80
120550	EVR25	28-35mm	21,0	18,0	993,00



BOBINE E CONNETTORI ELETTRICI / COIL AND IP65 ELECTRIC CONNECTORS

120552	018F6182	24V 50Hz-10W-IP20			€uro 46,40
120554	018F6192	115V 50Hz-10W-IP20			46,40
120556	018F6193	220-230V 50Hz-10W-IP20			46,40



110229	9150/R02	CONNETTORE ELETTRICO / ELECTRIC CONNECTOR			€uro 4,40
380515	JB 100	CONNETTORE ELETTRICO C/CAVO MT.1 / 1 MT. CABLE ELECTRIC CONNECTOR			7,30

I PREZZI NON INCLUDONO LE BOBINE / PRICES DO NOT INCLUDE THE COILS

PRESSOSTATI DANFOSS
DANFOSS PRESSURE SWITCHES

PRESSOSTATI DIFFERENZIALI OLIO RITARDO 90" (*)
 danfoss differential oil pressure controls 90" delay

120966	MP 54	LP - 1 / 12	0,65 Fix	Man.	€uro 412,00
120968	MP 55	LP - 1 / 12	0,3 / 4,5	Man.	429,10



(*) = disponibili su richiesta con ritardo 60 e 120sec./ available on request 60 and 120" delay versions

PRESSOSTATI DANFOSS

DANFOSS PRESSURE SWITCHES

CODICE CODE	MODELLO MODEL	CAMPO RANGE BAR	DIFF.LE DIFFERENTIAL BAR	REINS. RESET	LISTINO PRICE LIST Euro
----------------	------------------	-----------------------	--------------------------------	-----------------	-------------------------------

PRESSOSTATI DI BASSA PRESSIONE

LOW PRESSURE SWITCHES

120950	KP 1 0601101	LP - 0,2 / 7,5	Min 0,7- Max 4	Auto.		88,10
120952	KP 1 0601103	LP - 0,9 / 7,0	0,7 Fix	Man.		93,10
120954	KP 2 0601120	LP - 0,2 / 5,0	Min 0,4- Max 1,5	Auto.		88,10

PRESSOSTATI DI ALTA PRESSIONE

HIGH PRESSURE SWITCHES

120956	KP 5 0601171	HP - 6 / 32	Min 1,8 - Max 6	Auto.		88,10
120958	KP 5 0601173	HP - 10 / 32	3 Fix	Man.		93,10

PRESSOSTATI DI ALTA PRESSIONE CONTROLLO CONDENSAZIONE

CONDENSING CONTROL HIGH PRESSURE SWITCHES

120959	KPR 5	HP - 6 / 18	Min 1,25 - 2,5	Auto.	88,10
--------	-------	-------------	----------------	-------	-------

PRESSOSTATI DOPPI

DUAL PRESSURE SWITCHES

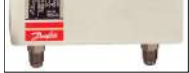
120960	KP 15 0601261	LP-0,2/7,5 - HP 6/32	MIN 0,7/4- MAX 4FIX	CONVERT.*		174,90
120962	KP 15 0601265	LP-0,2/7,5 - HP 6/32	MIN 0,7/4- MAX 4FIX	LP AUT.HP AUT.		147,40
120964	KP 15 0601264	LP-0,2/7,5 - HP 6/32	MIN 0,7/4- MAX 4FIX	LP AUT.HP MAN.		165,40

* = reset configurabile: alta - bassa - alta & bassa / *adjustable reset*: HP/LP/LP+HP

ACCESSORI PER PRESSOSTATI / PRESSURE SWITCH ACCESSORIES

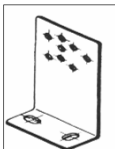
900614	CPL1000	1/4"SAE			10,00
900615	CPL1500-DPR	1/4"SAE + depr.			12,50
120970	STFT1	staffa a squadra / <i>square mounting bracket</i>			9,20

TERMOSTATI DANFOSS IN KIT DI MANUTENZIONE

MAINTENANCE KIT DANFOSS THERMOSTATS

CODICE CODE	MODELLO MODEL	TEMP. ATTACCO E STACCO CUT-IN--CUT OUT TEMP. °C	TIPO TYPE	ELEM. SENS. THERM. ELEM. mm.	
120978	077B7001	-13,5 / -25 (cold.pos.) -- +2 / +5,5 (warm pos)	A	1.300	28,60
120982	077B7008	-1 / -8,5 (cold.pos.) -- +11,5 / +6 (warm pos)	B	2.000	28,80



UTILIZZATO PER ARMADI E VETRINE COMMERCIALI / FOR COMMERCIAL REFRIGERATORS
UTILIZZATO PER REFRIGERATORI DI BIBITE / FOR BEVERAGE COOLERS

PRESSOSTATI RANCO
RANCO PRESSURE SWITCHES

CODICE CODE	MODELLO MODEL	CAMPO IMPIEGO RANGE BAR	DIFF.LE DIFFERENTIAL BAR	REINS. RESET	LISTINO PRICE LIST €uro
----------------	------------------	-------------------------------	--------------------------------	-----------------	-------------------------------

PRESSOSTATI DI BASSA PRESSIONE / LOW PRESSURE SWITCHES

121000	016-H6703		LP - 0,3 / 7,0	Min. 0,6- Max. 4	Auto.	49,40
121003	016-H6705		LP - 0,3 / 7,0	0,6 Fix.	Man.	54,50

PRESSOSTATI DI ALTA PRESSIONE / HIGH PRESSURE SWITCHES

121006	016-H6750		HP 7 / 30	Min. 2,5- Max. 8	Auto.	52,30
121009	016-H6751		HP 7 / 30	3,2 Fix.	Man.	57,40



PRESSOSTATI DOPPI / DUAL PRESSURE SWITCHES

121012	017-H4701		LP-0,3/7 - HP7/30	LP-0,6/ 4-HP 3,5FIX	Auto.	91,80
121015	017-H4705		LP-0,3/7 - HP7/30	LP-0,6/ 4-HP 3,5FIX	LP AUT.- HP MAN.	103,20
121018	017-H4703		LP-0,3/7 - HP7/30	LP-0,6FIX-HP 3,5FIX	LP MAN.- HP MAN.	99,90

PRESSOSTATI DIFFERENZIALI OLIO / OIL DIFFERENTIAL PRESSURE SWITCHES

121024	P30-3701-90"	LP - 0,3 / 4		0,5 Fix	Man.	226,00
121030	P30-5826-120"	LP - 0,6 Fix		0,5 Fix	Man.	216,80

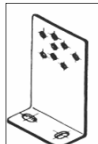
ACCESSORI PER PRESSOSTATI / PRESSURE SWITCH ACCESSORIES

900614	CPL1000	1/4"SAE				10,00
900615	CPL c/depress.	1/4"SAE				12,50
120970	STFT1	staffa a squadra / square mounting bracket				9,20

TERMOSTATI RANCO
RANCO THERMOSTATS

CODICE CODE	MODELLO MODEL	TEMP. ATTACCO CUT-IN TEMP °C	DIFF.LE DIFFERENTIAL °C	ELEM.SENS. THERMOST. ELEM. mm	Tipo	LISTINO PRICE LIST €uro
----------------	------------------	------------------------------------	-------------------------------	-------------------------------------	------	-------------------------------

TERMOSTATI SERIE "O16" / "O16" THERMOSTATS

121100	016-6901	Min. -18 / Max. +13		1,5 Fix.	=	A *	68,30
121102	016-6950	Min. -35 / Max. -07		1,7 -12	2.100	B *	66,00
121104	016-6951	Min. -18 / Max. +13		1,7 -12	2.100	B *	72,30
121106	016-6954	Min. -0,5 / Max. +25		1,7 -12	2.100	B *	68,30
121108	016-6981	Min. -0,5 / Max. +25		1,7 -12	2.100	C *	80,30

* A= capillare incorporato per contr. Temp. Ambiente / for ambient temperature

* B= capillare con terminale spiralato/coiled capillary 9,5x38 mm.

* C= capillare con bulbo cross-ambient/capillary with cross- ambient bulb 14,5x140 mm.

121110	K50-3485	Min.+1,5 / Max.+0,4 (+11)		1.200	C *	19,60
121112	K50-P1117	Min. -34 / Max. -16 (-12)		2.000	B *	20,10
121116	K50-P1125	Min. -18 / Max. -9,5 (+9,5)		1.200	A *	20,10

* A = UTILIZZATO PER: ARMADI/VETRINE COMM.LI / FOR COMMERCIAL REFRIGERATORS

* B = UTILIZZATO PER: ARMADI/VETRINE COMM.LI DI B.T. / FOR B.T. COMMERCIAL REFRIGERATORS

* C = UTILIZZATO PER: REFRIGERATORI DI BIBITE / FOR BEVERAGE COOLERS

TERMOSTATI RANCO
RANCO THERMOSTATS

TERMOSTATI RANCO "VARIFIX"

"VARIFIX" RANCO THERMOSTATS



CODICE CODE	MODELLO MODEL	DESCRIZIONE DESCRIPTION	LISTINO PRICE LIST Euro
121126	VC1	FRIGORIFERI DOMESTICI / domestic refrigerators	30,50
121134	VS5	CONGEL.C/ALLARME (N.A.) / Freezers with allarm (normally on)	33,40
121142	VT9	FRIGORIFERI A DUE PORTE / two doors domestic refrigerators	35,10

VALVOLE SOLENOIDI A 4 VIE RANCO
4-WAYS RANCO SOLENOID VALVES



CODICE CODE	MODELLO MODEL	CAPACITA' kw min. / max. R407C	CAPACITA' kw min. / max. R410A	CAPACITA' kw min. / max. R134a	ATTACCHI CONNEC. mm	LISTINO PRICE LIST Euro
121200	V2-408060-200	2,81 / 6,33	3,17 / 7,74	2,46 / 4,92	9,70/12,80	101,00
121202	V3-412080-800	3,87 / 9,85	4,57 / 12,31	3,17 / 7,74	12,80/19,20	115,40
121203	V6-412080-100	3,87 / 18,99	4,57 / 23,92	3,17 / 14,77	12,80/19,20	152,60
121204	V10-414120-100	11,25 / 33,06	13,01 / 41,85	9,85 / 26,03	19,20/22,40	234,00
121206	V12-4220T0-900	22,86 / 46,78	26,38 / 58,91	18,99 / 36,93	28,57/34,92	499,40

BOBINE PER VALVOLE RANCO / RANCO VALVE COILS

121212	LDK-424801	220V 50/60Hz	29,30
121216	LDK-414803	24V 50/60Hz	29,30

TERMOSTATI TEMPORIZZATORI E RELAY
TIMERS, THERMOSTATS & RELAY

TERMOSTATI PRODIGY / PRODIGY THERMOSTATS

CODICE CODE	MODELLO MODEL	CAMPO RANGE °C	CAPILLARY CAPILLARY mm	DESCRIZIONE DESCRIPTION	DIF.LE DIFF. °C	LISTINO PRICE LIST Euro
122500	A/2000 **	-35 / +35	-	AMBIENT APPL.	2	22,40
122502	F/2000 **	-35 / +35	1.500	APPL. REM.	2	22,40
122506	F2000-fine sbr. **	0 / +40	1.500	END. DEFROST.	2	22,40
122508	TR711N **	-35 / +35	1.500	INCASSO	2	19,20
122510	TR711N **	0 / +40	1.500	INCASSO	2	19,20

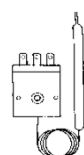
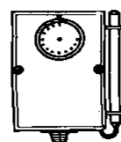
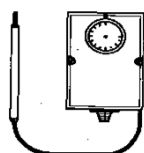

**= prodotti Prodigy ad esaurimento

TEMPORIZZATORI



122527	CDC-13102/24	TEMPORIZZATORE DI SBRINAMENTO REGOLABILE / DEFROST TIMER	81,60
810585	FINDER 65.31 20A	RELAY	32,60

VALVOLE TERMOSTATICHE ALCO
ALCO THERMOSTATIC EXPANSION VALVES



TABELLA DI SELEZIONE UGELLO / SELECTION CHART FOR ORIFICE

MODELLO MODEL	R134a		R407C		R404A/R507		R22		UGELLO
	TYPE	NOM.CAP. kW	TYPE	NOM.CAP. kW	TYPE	NOM.CAP. kW	TYPE	NOM.CAP. kW	
TCLE	25MW	1,5	50NW	2,1	25SW	1,3	50HW	1,9	X22440-B1B
	75MW	2,9	100NW	4,0	75SW	2,6	100HW	3,7	X22440-B2B
	150MW	6,1	200NW	8,5	150SW	5,6	200HW	7,9	X22440-B3B
	200MW	9,3	300NW	12,9	200SW	8,4	250HW	11,9	X22440-B3,5B
	250MW	13,5	400NW	18,7	250SW	12,2	300HW	17,3	X22440-B4B
	350MW	17,3	550NW	24,0	400SW	15,7	500HW	22,2	X22440-B5B
	550MW	23,6	750NW	32,9	600SW	21,5	750HW	30,4	X22440-B6B
	750MW	32,0	1000NW	44,4	850SW	29,0	1000HW	41,1	X22440-B7B
	900MW	37,2	1150NW	51,7	1000SW	33,8	1200HW	47,8	X22440-B8B
TJRE	11MW	45,0	14NW	62,0	12SW	40,0	14HW	58,0	X11873-B4B
	13MW	57,0	17NW	80,0	14SW	51,0	18HW	74,0	X11873-B5B
TERE	16MW	71,0	21NW	99,0	18SW	63,0	22HW	91,0	X9117-B6B
	19MW	81,0	25NW	112,0	20SW	72,0	26HW	104,0	X9117-B7B
	25MW	112,0	33NW	155,0	27SW	99,0	35HW	143,0	X9117-B8B
	31MW	135,0	42NW	188,0	34SW	120,0	45HW	174,0	X9117-B9B
TIRE	45MW	174,0	52NW	241,0	47SW	154,0	55HW	223,0	X9166-B10B
THRE	55MW	197,0	71NW	273,0	61SW	174,0	75HW	253,0	X9144-B11B
	68MW	236,0	94NW	327,0	77SW	209,0	100HW	302,0	X9144-B13B

CODICE CODE	MODELLO MODEL	DESCRIZIONE DESCRIPTION	LISTINO PRICE LIST
122031	X22440 B1B...B8B	ugello per / orifice for TCLE	111,20
122014	X11873 B4B/B5B	ugello per / orifice for TJRE	313,80
122016	X9117 B6B...B9B	ugello per / orifice for TERE	328,30
122018	X9166 B10B	ugello per / orifice for TIRE	461,40
122020	X9144 B11B/B13B	ugello per / orifice for THRE	705,50
122028	XB1019-HW100-1B R22	el. term. per / element for TCLE/TJRE 1,5mt cap.	203,80
122040	XB1019-MW-1B R134a	el. term. per / element for TCLE/TJRE 1,5mt cap.	199,20
122042	XB1019-SW-1B R404A	el. term. per / element for TCLE/TJRE 1,5mt cap.	206,20
122029	XB1019-NW100 -1B R407C	el. term. per / element for TCLE/TJRE 1,5mt cap.	189,00
122030	XC726-HW100-2B R22	el. term. per / element for Tere/Tire/Thre 3mt cap.	451,50
122022	XC726-MW-2B R134a	el. term. per / element for Tere/Tire/Thre 3mt cap.	424,20
122024	XC726-SW-2B R404A	el. term. per / element for Tere/Tire/Thre 3mt cap.	445,70
122026	XC726-NW-2B R407C	el. term. per / element for Tere/Tire/Thre 3mt cap.	422,60
122048	C 501 5 10x16mm	corpo valvola per / valve body for XB1019....1B	49,30
122033	C 501 7 12x16mm	corpo valvola per / valve body for XB1019....1B	55,20
122037	A576 16x22mm	corpo valvola per / valve body for XB1019....1B	85,80
nc.	10331 22x22mm	corpo valvola per / valve body for XB1019....1B (tjre)	119,00
122039	9153 22x22mm	corpo valvola per / valve body for XC726....2B	139,00



VALVOLE TERMOSTATICHE SPORLAN R407C/R410A
R407C/R410A SPORLAN THERMOSTATIC EXPANSION VALVES

CODICE CODE	MODELLO MODEL	RESA FRIG. CAP.KW.	REFR. REFR.	ATTACCHI CONNECTIONS	EQUALIZ. EQUALIZER	LISTINO PRICE LIST
-10 / +32°C						
130000	FBNE3 CP100	10,50	R407C	3/8"x1/2"ODF	EXT.	101,00
130002	FBNE5 CP100	17,50	R407C	1/2"x5/8"ODF	EXT.	101,00
130004	FBNE8 CP100	28,00	R407C	1/2"x5/8"ODF	EXT.	101,00
130006	EBSNE8CP100	28,00	R407C	5/8"x7/8"ODF	EXT.	216,00
130008	EBSNE11CP100	38,00	R407C	5/8"x7/8"ODF	EXT.	222,00
130010	EBSNE15CP100	52,50	R407C	7/8"x1.1/8"ODF	EXT.	222,00
130012	EBSNE20CP100	70,00	R407C	7/8"x1.1/8"ODF	EXT.	222,00
+5 / +55°C						
130013	ONE20 CP100	77,30	R407C	7/8"x1.3/8"ODF	EXT.	280,00
130014	ONE30 CP100	106,00	R407C	1.1/8"x1.3/8"ODF	EXT.	280,00
130016	ONE40 CP100	140,00	R407C	1.1/8"x1.3/8"ODF	EXT.	519,00
130018	ONE55 CP100	191,00	R407C	1.1/8"x1.3/8"ODF	EXT.	519,00
130020	ONE70 CP100	253,00	R407C	1.1/8"x1.3/8"ODF	EXT.	519,00
130100	BBIZE8 GA	33,00	R410A	1/2"x5/8"ODF	EXT.	143,00
130102	BBIZE12,5 GA	43,50	R410A	5/8"x7/8"ODF	EXT.	202,00
130104	BBIZE15 GA	50,80	R410A	5/8"x7/8"ODF	EXT.	202,00



PRODOTTI VARI ALCO - JOHNSON CONTROLS

ALCO OTHER PRODUCTS

CODICE <i>CODE</i>	MODELLO <i>MODEL</i>	DESCRIZIONE <i>DESCRIPTION</i>	LISTINO <i>PRICE LIST</i> €uro
------------------------------	--------------------------------	--	---

CARTUCCE DISIDRATANTI ANTIACIDO ALCO / ALCO FILTER DRIER CORES

122032	H48	DEHYDRATING SOLID CORES 48CC
122034	W48	ANTIACID SOLID CORES 48CC
122049	S48	DEHYDRATING SOLID CORES 48CC
122036	H100	DEHYDRATING SOLID CORES 100CC



FILTRI DEIDRATATORI DOPPIO FLUSSO SERIE BFK

BFK DOUBLE-FLOW FILTER DRIERS

CODICE <i>CODE</i>	MODELLO <i>MODEL</i>	ATT. <i>CONN.</i>	CAPACITA' <i>CAPACITY W</i> R22	CAPACITA' <i>CAPACITY W</i> R134a	CAPACITA' <i>CAPACITY W</i> R404A/R507	CAPACITA' <i>CAPACITY W</i> R410A	LISTINO <i>PRICE LIST</i> €uro
122052	BFK083S	3/8"ODF	22.500	20.600	14.700	22.200	62,20
122056	BFK084S	1/2"ODF	31.300	28.700	20.400	30.900	62,20
122064	BFK163S	3/8"ODF	26.000	23.800	17.000	25.700	77,70
122068	BFK164S	1/2"ODF	37.600	34.400	24.500	37.100	77,70
122072	BFK165S	5/8"ODF	40.400	37.000	26.300	39.900	77,70
122050	BFK083	3/8"SAE	18.400	16.900	12.000	18.200	62,20
122054	BFK084	1/2"SAE	28.100	25.800	18.300	27.800	62,20
122062	BFK163	3/8"SAE	22.900	21.000	14.900	22.600	77,70
122066	BFK164	1/2"SAE	30.000	27.500	19.600	29.600	77,70
122070	BFK165	5/8"SAE	38.500	35.300	25.100	38.000	77,70

VARIATORI DI VELOCITA' PER VENTILATORI MONOFASE, COMPLETI DI CAVO E CONNETTORE

ELECTRONIC FAN SPEED CONTROLLER, WITH CONNECTING CABLE AND CONNECTOR

CODICE <i>CODE</i>	MODELLO <i>MODEL</i>	CORR.MAX <i>AX OPER.CUR.</i> A	CAMPO <i>PRESS.RANGE</i> BAR	CAVO <i>CABLE</i> LENGTH	LISTINO <i>PRICE LIST</i> €uro
122046	FSX-41S	4,0	4 / 12,5	1,5MT	375,70
122047	FSX-43S	4,0	12,4 / 28,4	1,5MT	426,60
123571	P12PR/RM	4,0	10-25 / 22-42	--	202,00



KIT TEST ACIDITA' PER OLI MINERALI E POE / POE & MINERAL OIL ACID TEST KIT

122074	AOK U01	PER OLI POE E MINERALI / FOR POE AND MINERAL OILS	61,40
--------	---------	---	--------------



MOTOVENTILATORI

MOTOR FANS

MOTORI ELETTRICI POLIVALENTI LINEA ECONOMICA

CHEAP POLYVALENT ELECTRICAL MOTORS

CODICE	WATT	TENSIONE	WATT RESI	DIAM. SUGG. FAN	LISTINO
CODE	WATT	VOLTAGE	W. OUTPUT	DIAM. SUGG. FAN	PRICE LIST
					€uro
800001	5 Watt	230-240/1/BF	5 W	200mm	22,80
800003	10 Watt	230-240/1/BF	10 W	230-254mm	26,20
800005	16 Watt	230-240/1/BF	16 W	300mm	34,40
800000K	5 Watt	230-240/1/BF	5 W	200mm	confez. 12 pz. 234,20
800002K	10 Watt	230-240/1/BF	10 W	230-254mm	confez. 12 pz. 297,70



MOTORI ELETTRICI POLIVALENTI

POLYVALENT ELECTRICAL MOTORS

CODICE	MODELLO	TENSIONE	WATT RESI	VENT. SUGG. TA	LISTINO
CODE	MODEL	VOLTAGE	W. OUTPUT	DIAM. SUGG. FAN	PRICE LIST
					€uro
800000	5 Watt	230-240/1/BF	5 W	200mm	33,40
800002	10 Watt	230-240/1/BF	10 W	230-254mm	36,30
800004	16 Watt	230-240/1/BF	16 W	300mm	46,70
800006	25 Watt	230-240/1/BF	25 W	300mm	62,80
800008	34 Watt	230-240/1/BF	34 W	300mm	77,10
800010	16 Watt A.L.	230-240/1/BF	16 W	300mm	48,90
800012	25 Watt A.L.	230-240/1/BF	25 W	300mm	67,90



VENTOLE ASPIRANTI

SUCTION BLADES

CODICE	MODELLO	LISTINO
CODE	MODEL	PRICE LIST
		€uro
800100	V5D154-28-AA	4,30
800102	V5D172-28-AA	4,30
800104	V5D200-22-AA	5,40
800106	V5D230-22-AA	6,50
800108	V5D254-22-AA	6,50
800110	V5D300-22-AA	13,40
800112	V5D300-34-AA	13,40



STAFFE

BRACKETS

CODICE	MODELLO	LISTINO
CODE	MODEL	PRICE LIST
		€uro
800114	H52	4,90
800116	H72	4,90
800118	H84	5,90
800120	H109	7,10

MOTOVENTILATORI A ROTORE ESTERNO COMPLETI DI GRIGLIA ASPIRANTI

SUCTION EXTERNAL ROTOR FAN MOTORS WITH GUARD GRILL

CODICE	MODELLO	TENSIONE	D. VENTOLA	LISTINO
CODE	MODEL	VOLTAGE	DIAM. OF FAN	PRICE LIST
				€uro
800043	W5G30	230/1/50	300	160,20
800045	W5G35	230/1/50	350	181,50
800047	W5G40	230/1/50	400	210,20
800037	W5G45	230/1/50	450	330,10
800049	W5G30T	380/3/50	300	160,20
800051	W5G35T	380/3/50	350	181,50
800053	W5G40T	380/3/50	400	210,80
800055	W5G45T	380/3/50	450	318,00



REGOLATORI DI GIRI / speed regulators

ECLIPSE	REGOLATORE MANUALE DI GIRI MONOFASE MAX 4A	ECLIPSE HHR-04	149,30
---------	--	----------------	--------

MOTOVENTILATORI

MOTOR FANS

MOTORI ELETTRICI EBM PRIVI DI GRIGLIA

EBM AXIAL FAN MOTORS WITHOUT GUARD GRILL

CODICE CODE	MODELLO MODEL	TENSIONE VOLTAGE	RPM rpm	D. VENTOLA DIAM. OF FAN	LISTINO PRICE LIST Euro
800042	A4E300 AP2601	220/1/50	1325	300mm	151,40
800044	A4E350 AP0601	220/1/50	1325	350mm	222,40
800046	A4E400 AP0201	220/1/50	1325	400mm	248,10
800200	A4E450 AP0101	220/1/50	1325	450mm	352,50
800202	A4E500 AJ0101	220/1/50	1325	500mm	560,50
800204	A6E630 AN0101	220/1/50	900	630mm	594,50
800048	A4D300 AP2801	380/3/50	1325	300mm	213,40
800050	A4D350 AP0801	380/3/50	1325	350mm	244,50
800052	A4D400 AP1201	380/3/50	1325	400mm	254,90
800205	A4D450 AP0101	380/3/50	1325	450mm	376,80
800206	A4D500 AD0301	380/3/50	1325	500mm	560,50
800208	A6D630 AN0101	380/3/50	900	500mm	594,50



CODICE CODE	MODELLO MODEL	LISTINO PRICE LIST Euro
800122	GRIGLIA x 300mm.	30,00
800124	GRIGLIA x 350mm.	35,70
800126	GRIGLIA x 400mm.	54,20
800128	GRIGLIA x 450mm.	63,30
800130	GRIGLIA x 500mm.	75,80
800132	GRIGLIA x 630mm.	125,30



MOTOVENTILATORI A ROTORE ESTERNO ZIEHL ABEGG COMPLETI DI GRIGLIA

ZIEHL ABEGG EXTERNAL ROTOR FAN MOTORS WITH GUARD GRILL

CODICE CODE	MODELLO MODEL	TENSIONE VOLTAGE	RPM rpm	DIAM. VENTOLA DIAM. OF FAN	LISTINO PRICE LIST Euro
800220	FN030-4EK	220/1/50	1325	300mm	198,00
800222	FN035-4EK	220/1/50	1325	350mm	254,20
800224	FN040-4EK	220/1/50	1325	400mm	290,00
800226	FN045-4EK	220/1/50	1325	450mm	422,50
800228	FN050-4EK	220/1/50	1325	500mm	571,30
800230	FN063-6EK	220/1/50	900	630mm	629,80
800234	FN040-VDK	380/3/50	1325	400mm	301,90
800236	FN045-VDK	380/3/50	1325	450mm	522,90
800238	FN050-VDK	380/3/50	1325	500mm	571,30
800240	FN063-6 DK	380/3/50	900	630mm	655,90
800242	FN080-S DA	380/3/50	900	800mm	1218,40



MOTOVENTILATORI COMPATTI PER VETRINE REFRIGERATE

COMPACT AXIAL FAN MOTORS FOR DISPLAY CASES

CODICE CODE	MODELLO MODEL	TENSIONE VOLTAGE	GIRI/MIN. RPM.	AIR FLOW mc/h	LISTINO PRICE LIST Euro
800066	120x120x38	230/1/BF	2.500/3.000	149/184	54,20
800068	120x120x25	230/1/BF	2.400/2.900	110/137	54,20
800070	92x92x25	230/1/BF	2.500/3.000	51/58	54,20
800072	80x80x38	230/1/BF	2.500/3.100	44/53	51,90
CAVO-	cavo quick-connect				7,25



MOTOVENTILATORI

MOTOR FANS

MOTOVENTILATORI CENTRIFUGHI

CENTRIFUGAL FAN MOTORS

CODICE CODE	MODELLO MODEL	TENSIONE VOLTAGE	LUNG. VENT. DIM.FAN	LISTINO PRICE LIST Euro
800076	TG 90-15	220/1/50	90mm	48,90
800078	TG180-20	220/1/50	180mm	57,40
800080	TG270-30	220/1/50	270mm	75,80
800082	TGD180-30	220/1/50	2 x 180mm	97,70
800079	TGD270-30	220/1/50	2 x 270mm	115,60

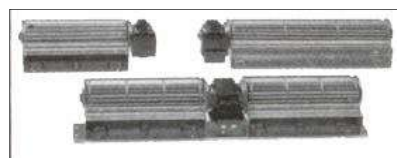

MOTOVENTILATORI CON ANELLO PER VETRINE REFRIGERATE

SUCTION RING MOTOR FANS FOR DISPLAY CASES

CODICE CODE	MODELLO MODEL	TENSIONE VOLTAGE	LISTINO PRICE LIST Euro
800014	1W-DIAM96AA	230-240/1/BF	62,80
800016	1W-DIAM96AP	230-240/1/BF	62,80
800018	5W-DIAM154	230-240/1/BF	53,50
800020	5W-DIAM172	230-240/1/BF	55,30
800022	5W-DIAM200	230-240/1/BF	56,90
800024	5W-DIAM230	230-240/1/BF	66,70
800026	10W-DIAM230	230-240/1/BF	67,90

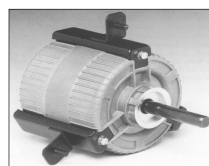
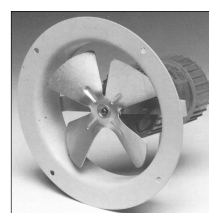

MOTORI ELETTRICI VENTILATI REVERSIBILI

REVERIBLE FAN MOTORS

CODICE CODE	MODELLO MODEL	TENS. VOLTAGE	WATT W. OUT	VENTOLA DIAM. OF. FAN	ALBERO SHAFT	LISTINO PRICE LIST Euro
800086	W100/M/REV.	220/1/50	100	400mm	1/2"	187,10
800087	W120/M/REV.	220/1/50	120	400mm	1/2"	195,20
800088	W150/M/REV.	220/1/50	150	400mm	1/2"	199,30
800090	101T40-185	380/3/50	150	400mm	1/2"	199,30

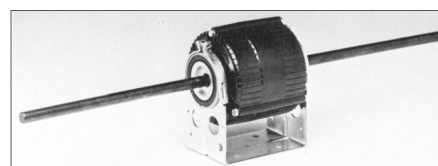

MOTORI ELETTRICI PER FAN COIL A TRE VELOCITA'

THREE SPEED FAN COIL MOTORS

CODICE CODE	MODELLO MODEL	TENS. VOLTAGE	WATT W. OUT	ALBERO SHAFT	LISTINO PRICE LIST Euro
800097	K31 8323M	220/1/50	30	1 x 1/2"	182,60
800092	103M-2025-1	220/1/50	80	1 x 1/2"	191,90
800095	K35-MMV03	motoventilatore multivelocità monoalbero / one shaft multispeed fan motor			230,30
800098	K31 8024B	220/1/50	40	2 x 1/2"	240,00
800096	103B-2025-3	220/1/50	50	2 x 1/2"	237,70
800099	BMV03	motoventilatore multivelocità bialbero / double shaft multispeed fan motor			240,00

TUBI E LASTRE ISOLANTI CLASSE 1

INSULATING TUBES AND PLATES

TUBI ISOLANTI CLASSE 1 CLASS 1 INSULATING TUBES



CODICE	MODELLO	CONFEZ.	LISTINO
CODE	MODEL	CARTON	PRICE LIST
	diam. nom.	mt	€uro/mt

CODICE	MODELLO	CONFEZ.	LISTINO
CODE	MODEL	CARTON	PRICE LIST
	diam. nom.	mt	€uro/mt

Spessore nominale / Nominal thickness 6mm

810000	SP6x06	496	1,20
810005	SP6x08	432	1,25
810010	SP6x10	364	1,25
810015	SP6x12	316	1,30
810020	SP6x14	280	1,45
810025	SP6x18	220	1,55
810030	SP6x22	180	1,70
810035	SP6x28	130	2,15
810040	SP6x35	100	2,65

Spessore nominale / Nominal thickness 9mm

810001	SP9x10	266	1,75
810006	SP9x12	234	1,75
810011	SP9x15	192	1,95
810016	SP9x18	166	2,10
810021	SP9x22	136	2,15
810026	SP9x28	98	3,00
810031	SP9x35	76	3,35
810036	SP9x42	60	3,80
810041	SP9x48	50	4,25
810046	SP9x54	48	5,25
810051	SP9x60	46	5,60
810061	SP9x76	40	7,40
810066	SP9x89	36	9,15

CODICE	MODELLO	CONFEZ.	LISTINO
CODE	MODEL	CARTON	PRICE LIST
	diam. nom.	mt	€uro/mt

CODICE	MODELLO	CONFEZ.	LISTINO
CODE	MODEL	CARTON	PRICE LIST
	diam. nom.	mt	€uro/mt

Spessore nominale / Nominal thickness 13mm

810002	SP13x10	172	2,60
810007	SP13x12	162	2,65
810012	SP13x15	136	2,95
810017	SP13x18	118	3,10
810022	SP13x22	98	3,25
810027	SP13x28	78	3,85
810032	SP13x35	58	4,60
810037	SP13x42	48	5,30
810042	SP13x48	40	5,95
810047	SP13x54	34	7,30
810052	SP13x60	32	8,05
810057	SP13x70	26	9,70
810067	SP13x89	24	12,35

Spessore nominale / Nominal thickness 19mm

810003	SP19x18	72	6,10
810008	SP19x22	64	6,45
810013	SP19x28	48	7,75
810018	SP19x35	36	9,25
810023	SP19x42	32	10,80
810028	SP19x48	24	12,05
810033	SP19x54	24	13,95
810038	SP19x60	22	14,70
810048	SP19x76	18	18,75
810053	SP19x89	18	20,45

LASTRE ISOLANTI CLASSE 1

INSULATING PLATES CLASS 1

CODICE	MODELLO	SPESSORE	CONFEZ.	LISTINO
CODE	MODEL	THICKNESS	CARTON	PRICE LIST
		mm	mq	€uro
810004	Lastra sp.6	6	30	€mq 26,00
810009	Lastra sp.9	9	20	€mq 35,00
810014	Lastra sp.13	13	14	€mq 43,00
810019	Lastra sp.19	19	10	€mq 60,00



COLLANTE PER LASTRE GLUE FOR INSULATING PLATES

810024	ISOLGLUE	conf. 850gr.	LISTINO
--------	----------	--------------	---------



PRICE LIST
€uro

37,55

ISOLANTI
INSULATING

ROLOI ANTICONDENSA ADESIVI E PRODOTTI CHIMICI

INSULATING ROLLS AND CHEMICALS



CODICE CODE	MODELLO MODEL	DIMENSIONI DIMENSIONS	TIPO TYPE	LISTINO PRICE LIST
		mm		€uro
810029	PREST900	10000x50	CATRAMÉ / cork type	33,50
810044	ALLUM030	30000x50	ALLUMINIO / allumin. type	33,00
810034	PLAST 900	10000x50	PLAST. RINF/ reinf. type	14,40
810050	WHITE 900	10000x50	PLAST. WHITE / white type	14,40
810054	NASTRO TEL. GRIGIO	10000x50	TELATO GRIGIO / grey	12,80
810049	TEFLON	25000x12	TEFLON	4,80
810055	NASTRO ISOL. TEMFLEX	19x25	COLORI VARI / Multicolor	4,80
810058	NASTRO ISOL. NERO	3,8x25	NERO / black	8,50
810059	NASTRO ISOL. GRIGIO	3,8x25	GRIGIO / grey	8,50
810043	SILICONE 310ML	Bianco o Trasparente / White or transparent		11,20
810056	PU 1/750	Schiuma poliuretano / Poliuretano foam		31,50

FILTRI DEIDRATORI IN RAME PER FRIGORIFERI DOMESTICI

COPPER FILTER DRIERS FOR DOMESTIC REFRIGERATORS



CODICE CODE	MODELLO MODEL	DESCRIZIONE DESCRIPTION	ATT. CONNECT.	LISTINO PRICE LIST
			mm	€uro
810549	2V15G	FILTRO 2V 15GR / 2 Way filter 15gr	6 x 2,5	5,00
810551	2V25G	FILTRO 2V 25GR / 2 Way filter 25gr	6 x 2,5	7,00
810553	3V15G	FILTRO 3V 15GR / 3 Way filter 15gr	6 x 2,5	6,00
810555	3V25G	FILTRO 3V 25GR / 3 Way filter 25gr	6 x 2,5	8,00

CAPILLARI DI ESPANSIONE POLIVALENTI COMPLETI DI FILTRO

CAPILLARY KIT TUBES

CODICE CODE	MODELLO MODEL	PER HP FOR HP	LISTINO PRICE LIST
			€uro
810548	M-HBP 01	1/5	32,50
810550	M-HBP 02	1/4	32,50
810552	M-HBP 03	1/3-3/8	32,50
810554	M-HBP 04	1/2	32,50



CAPILLARI COMPLETI DI BOCCHETTONI / KIT CAPILLARY WITH NUTS

CODICE CODE	MODELLO MODEL	ATTACCHI CONNECTIONS	LUNGHEZZA LENGTH	LISTINO PRICE LIST
				€uro
900614	CPL 1000	1/4"SAE	1 mt	10,00
900615	CPLD 1500	1/4"SAE	1,5 mt	12,50



TUBI DI RAME
COPPER TUBES

TUBO RAME RICOTTO PER REFRIGERAZIONE / SOFT COPPER TUBE FOR REFRIGERATION

CODICE CODE	MODELLO MODEL D.I. x D.E.	PESO KG/MT	LISTINO PRICE LIST Euro/kg
811500	4 x 6 mm	0,140	*
811502	6 x 8 mm	0,196	*
811504	8 x 10 mm	0,252	*
811506	10 x 12 mm	0,307	*
811508	12 x 14 mm	0,363	*
811510	14 x 16 mm	0,419	*
811512	16 x 18 mm	0,475	*
811514	20 x 22 mm	0,587	*



TUBO RAME CRUDO IN VERGHE / HARD COPPER TUBE RODS

CODICE CODE	MODELLO MODEL D.I. x D.E.	PESO KG/MT	LISTINO PRICE LIST Euro/kg
811516	CR 6 x 8 mm	0,196	*
811518	CR 8 x 10 mm	0,252	*
811520	CR10 x 12 mm	0,307	*
811522	CR12 x 14 mm	0,363	*
811524	CR14 x 16 mm	0,419	*
811526	CR16 x 18 mm	0,475	*
811528	CR20 x 22 mm	0,587	*
811530	CR26 x 28 mm	0,755	*
811532	CR33 x 35 mm	0,950	*
811534	CR40 x 42 mm	1,146	*
811536	CR51 x 54 mm	2,201	*
***	CR60 x 64 mm	3,481	*
***	CR63 x 67 mm	3,649	*
***	CR72 x 76 mm	4,155	*



TUBO CAPILLARE / CAPILLARY TUBES

CODICE CODE	MODELLO MODEL D.I. x D.E.	PESO G/MT	LISTINO PRICE LIST Euro/kg
810538	0,91 x 2,2 mm	23	*
810540	1,24 x 2,4 mm	31	*
810542	1,37 x 2,6 mm	36	*
810544	1,83 x 3,1 mm	42	*
810546	2,16 x 3,7 mm	55	*

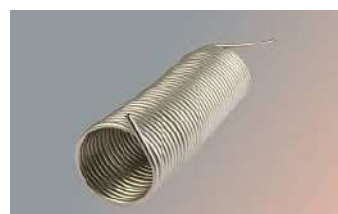

* = QUOTAZIONI SU RICHIESTA / PRICES ON REQUEST

PORTACAVI PER FISSAGGIO TUBO RAME
MOUNTING BRACKET FOR COPPER TUBES

CODICE CODE	MODELLO MODEL	PER TUBI DIAMETRO FOR DIAM. PIPES	LISTINO PRICE LIST Euro
810566	AFC08-12	8 - 12 mm	5,50
810568	AFC12-16	12 - 16 mm	5,50
810570	AFC16-22	16 - 22 mm	5,50
810572	AFC22-28	22 - 28 mm	7,70
810574	AFC28-34	28 - 34 mm	8,80
810576	AFC34-40	34 - 40 mm	11,00
810578	AFC40-46	40 - 46 mm	11,00
810580	AFC46-52	46 - 52 mm	12,65
810582	AFC52-58	52 - 58 mm	

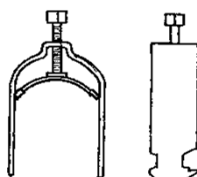

810584	BRMT2	BARRA DI FISSAGGIO / FIXING BAR MT.2	70,40
--------	-------	--------------------------------------	-------

TUBI DI RAME

COPPER TUBES

TUBO RAME PER CONDIZIONAMENTO CRUDO IN VERGHE / HARD COPPER TUBE RODS

CODICE CODE	MODELLO MODEL	DIAM. NOM. NOM. DIAM.	LISTINO PRICE LIST Euro/kg
901760	VERGA 3/4" MT. 5	19,05 X 1	**
901762	VERGA 7/8" MT. 5	22,22 X 1	**
901764	VERGA 1 " MT. 5	25,40 X 1	**
901766	VERGA 1-1/8 " MT. 5	28,57 X 1	**
901767	VERGA 1-1/4 " MT. 5	32,00 X 1	**
901768	VERGA 1-3/8 " MT. 5	34,92 X 1	**
901770	VERGA 1-5/8 " MT. 5	41,27 X 1	**



**= QUOTAZIONI SU RICHIESTA /Price on request

RACCORDERIA IN POLLICI

INCH FITTINGS

CURVE RAME 90° FF/ 90° FxF COPPER BENDS

CODICE CODE	MODELLO MODEL	DIAM. NOM. NOM. DIAM.	LISTINO PRICE LIST Euro
901700	CU90FFD 3/4"	mm. 19,05	3,80
901702	CU90FFD 7/8"	mm. 22,22	4,80
901704	CU90FFD 1"	mm. 25,40	7,90
901706	CU90FFD 1-1/8"	mm. 28,57	9,00
901708	CU90FFD 1-3/8"	mm. 34,92	14,00
901710	CU90FFD 1-5/8"	mm. 41,27	23,70



CURVE RAME 90° MF/ 90° MxF COPPER BENDS

901720	CU90MFD 3/4"	mm. 19,05	3,80
901722	CU90MFD 7/8"	mm. 22,22	5,80
901724	CU90MFD 1"	mm. 25,40	10,50
901726	CU90MFD 1-1/8"	mm. 28,57	9,50
901728	CU90MFD 1-3/8"	mm. 34,92	16,30
901730	CU90MFD 1-5/8"	mm. 41,27	28,40



MANICOTTI RAME FF / FxF COPPER COUPLINGS

901740	MAFFD 3/4"	mm. 19,05	1,60
901742	MAFFD 7/8"	mm. 22,22	2,70
901744	MAFFD 1"	mm. 25,40	3,50
901746	MAFFD 1-1/8"	mm. 28,57	4,80
901748	MAFFD 1-3/8"	mm. 34,92	6,60
901750	MAFFD 1-5/8"	mm. 41,27	9,40

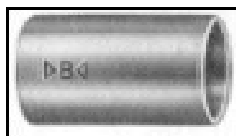

VALVOLE A SFERA IN POLLICI CON ATTACCO DI CARICA

INCH BALL VALVES WITH SHRADER

CODICE CODE	DIAM. NOM. NOM. DIAM.	LISTINO PRICE LIST Euro
SFERAC/SHR1/4	VALV. SFERA 1/4" - 6,35 mm.	33,50
SFERAC/SHR3/8	VALV. SFERA 3/8" - 9,57 mm.	34,60
SFERAC/SHR1/2	VALV. SFERA 1/2" - 12,57 mm.	36,70
SFERAC/SHR5/8	VALV. SFERA 5/8" - 15,87 mm.	42,00



STAFFAGGI PER TUBI DI RAME
MOUNTING BRACKET FOR COPPER TUBES

COLLARI ISOFONICI REALIZZATI IN ACCIAIO S235JR CON DADO DOPPIO M8-M10
FINITURA ZINCATA ELETTROLITICA CAMPO APPLICAZIONE -40+110°C

LISTINO
PRICE LIST
Euro/cad.

L115018	COLLARE C/GOMMA M8-M10 - 15-19 - 3/8"	confez. Pz.50	2,20
L115022	COLLARE C/GOMMA M8-M10 - 20-25 - 1/2"	confez. Pz.50	2,40
L115028	COLLARE C/GOMMA M8-M10 - 26-30 - 3/4"	confez. Pz.50	2,60
L115035	COLLARE C/GOMMA M8-M10 - 32-33 - 1"	confez. Pz.50	2,70
L115040	COLLARE C/GOMMA M8-M10 - 38-45 - 1.1/4"	confez. Pz.25	2,90
L115048	COLLARE C/GOMMA M8-M10 - 47-51 - 1.1/2"	confez. Pz.25	3,30
L115060	COLLARE C/GOMMA M8-M10 - 60-64 - 2"	confez. Pz.25	3,60
L115075	COLLARE C/GOMMA M8-M10 - 70-80 - 2.1/2"	confez. Pz.25	4,10
L115090	COLLARE C/GOMMA M8-M10 - 87-92 - 3"	confez. Pz.25	4,60
L115100	COLLARE C/GOMMA M8-M10 - 99-105 - 3.1/2"	confez. Pz.25	5,30



SUPPORTI ISOLATI
INSULATED SUPPORTS

DIAMETRI DIAMETERS	MODELLO MODEL	LISTINO PRICE LIST Euro/cad.	MODELLO MODEL	LISTINO PRICE LIST Euro/cad.
RAME - FERRO	SPESS. 13 MM		SPESS. 19 MM	
	SU13-10	10,550	SU19-10	11,950
	SU13-12	10,585	SU19-12	12,700
	SU13-16	10,985	SU19-16	12,750
3/4" - 3/8"	SU13-18	12,310	SU19-18	14,650
7/8" - 1/2"	SU13-22	13,070	SU19-22	15,250
1.1/8" - 3/4"	SU13-28	14,150	SU19-28	16,250
	SU13-35	15,470	SU19-35	17,950
1.5/8" - 1.1/4"	SU13-42	17,630	SU19-42	20,450
- 1.1/2"	SU13-48	20,090	SU19-48	22,950
	SU13-54	21,270	SU19-54	24,350
2.3/8" - 2"	SU13-60	23,970	SU19-60	27,150
	SU13-64	25,010	SU19-64	28,150
	SU13-67	26,090	SU19-67	29,700
2.3/4"	SU13-70	26,555	SU19-70	30,200
3" - 2.1/2"	SU13-76	30,195	SU19-76	34,150
	SU13-80	31,535	SU19-80	35,700
3.1/2" - 3"	SU13-89	35,095	SU19-89	39,300
	SU13-102	39,640	SU19-102	44,450



DIAMETRI DIAMETERS	MODELLO MODEL	LISTINO PRICE LIST Euro/cad.	MODELLO MODEL	LISTINO PRICE LIST Euro/cad.
RAME - FERRO	SPESS. 25 MM		SPESS. 32 MM	
	SU25-10	**	SU32-10	**
	SU25-12	**	SU32-12	**
	SU25-16	**	SU32-16	**
3/4" - 3/8"	SU25-18	16,050	SU32-18	20,350
7/8" - 1/2"	SU25-22	18,600	SU32-22	20,950
1.1/8" - 3/4"	SU25-28	20,450	SU32-28	22,150
	SU25-35	22,600	SU32-35	24,450
1.5/8" - 1.1/4"	SU25-42	25,600	SU32-42	27,400
- 1.1/2"	SU25-48	28,900	SU32-48	30,700
	SU25-54	30,450	SU32-54	32,800
2.3/8" - 2"	SU25-60	33,550	SU32-60	35,600
	SU25-64	35,100	SU32-64	37,950
	SU25-67	36,650	SU32-67	38,450
2.3/4"	SU25-70	37,700	SU32-70	39,500
3" - 2.1/2"	SU25-76	41,400	SU32-76	46,000
	SU25-80	43,950	SU32-80	47,050
3.1/2" - 3"	SU25-89	47,800	SU32-89	50,150
	SU25-102	54,050	SU32-102	56,350



RACCORDERIA IN OTTONE

BRASS FITTINGS

BOCCHETTONI SAE

SAE NUTS



CODICE CODE	MODELLO MODEL	ATTAC. CONNECT. SAE - foro	LISTINO PRICE LIST €uro
900350	BS-2	1/4" - 6,35	1,50
900591	BSC-2	1/4" - Cieco/blind	1,50
900506	BS-3M10	3/8" - 10,00	2,20
900374	BS-4	1/2" - 12,70	3,00
900386	BS-5	5/8" - 16,00	3,70
900398	BS-6	3/4" - 19,05	5,40
900410	BS-7	7/8" - 22,22	14,70
900434	BS-32	3/8" - 6,35	2,20
900446	BS-43	1/2" - 9,52	3,10
900458	BS-54	5/8" - 12,70	3,90
900494	BS-3M8	3/8" - 8,00	2,20
900506	BS-3M10	3/8" - 10,00	2,20
900518	BS-4M10	1/2" - 10,00	3,00
900530	BS-4M12	1/2" - 12,00	3,50
900542	BS-5M12	5/8" - 12,00	4,10

GIUNTI DIRITTI A DOPPIO BOCCHETTONE

SWIVEL NUTS UNIONS



CODICE CODE	MODELLO MODEL	ATTAC. CONNECT. SAE	LISTINO PRICE LIST €uro
900566	BSD-2	1/4"	5,30
900578	BSD-3	3/8"	6,80
900590	BSD-4	1/2"	9,60



GIUNTI SAE

SAE BRASS NIPPLES

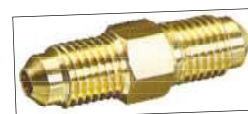

CODICE CODE	MODELLO MODEL	ATTAC. CONNECT. SAE	LISTINO PRICE LIST €uro
900351	NS-2	1/4"	2,70
900363	NS-3	3/8"	4,00
900375	NS-4	1/2"	5,70
900387	NS-5	5/8"	8,70
900399	NS-6	3/4"	14,90
900435	NS-23	1/4" x 3/8"	6,70
900447	NS-24	1/4" x 1/2"	9,40
900459	NS-34	3/8" x 1/2"	10,20
900471	NS-45	1/2" x 5/8"	17,90

GIUNTI SAE x NPT

SAE x NPT BRASS NIPPLES



CODICE CODE	MODELLO MODEL	ATTAC. CONNECT.	LISTINO PRICE LIST €uro
900483	NSN-2	1/4" sae x 1/4" npt	3,00
900495	NSN-3	3/8" sae x 3/8" npt	5,00
900507	NSN-4	1/2" sae x 1/2" npt	7,10
900519	NSN-6	3/4" sae x 3/4" npt	16,50
900531	NSN-8	1" sae x 1" npt	28,10
900543	NSNR-21	1/4" sae x 1/8" npt	2,90
900555	NSNR-32	3/8" sae x 1/4" npt	5,30
900567	NSNR-43	1/2" sae x 3/8" npt	9,70
900579	NSNR-54	5/8" sae x 1/2" npt	9,90

GOMITI SAE x NPT

SAE x NPT ELBOWS

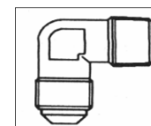

CODICE CODE	MODELLO MODEL	ATTAC. CONNECT.	LISTINO PRICE LIST €uro
900412	GSN-2	1/4" saex1/4" npt	6,40
900424	GSN-3	3/8" saex3/8" npt	10,00

RACCORDERIA IN OTTONE

BRASS FITTINGS

TEE SAE

SAE TEE CONNECTIONS



CODICE CODE	MODELLO MODEL	ATTAC. CONNECT. SAE	LISTINO PRICE LIST €uro
900353	TS-2	1/4"x1/4"x1/4"	4,00

TEE SAE x NPT

NPT x SAE TEE CONNECT.

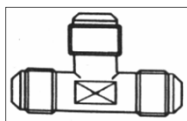

CODICE CODE	MODELLO MODEL	ATTAC. CONNECT. SAE x NPT	LISTINO PRICE LIST €uro
900504	TSN-221	1/4"x1/4"x1/8"	7,80

RACCORDO A T 6-4C01

T6-4C01 TEE FITTING



CODICE CODE	MODELLO MODEL	ATTAC. CONNECT.	LISTINO PRICE LIST €uro
900480	T6-4C01	1/4"SAE	10,50

GUARNIZIONI TRONCO CONICHE (*)

CONICAL COPPER GASKETS (*)



CODICE CODE	MODELLO MODEL	ATTAC. CONNECT. x SAE	LISTINO PRICE LIST €uro
900546	GTR-2	1/4"	0,50
900558	GTR-3	3/8"	0,50
900570	GTR-4	1/2"	0,60
900582	GTR-5	5/8"	0,60
900594	GTR-6	3/4"	0,90

(*) = FORNITI IN CONFEZIONE DA 100pz

(*) = SUPPLIED IN 100pcs PACKAGES

RIDUZIONI MASCHIO-FEMMINA SAE

MALE-FEMALE SAE REDUCING



CODICE CODE	MODELLO MODEL	ATTAC. CONNECT. SAE MxF	LISTINO PRICE LIST €uro
900349	RS-21MF	1/4"M. x 1/8"F.npt	7,20
900405	RS-2F516M	5/16"M. x 1/4"F.	8,70
900354	RS-23MF	1/4"M. x 3/8"F.	11,50
900361	RS-32MF	3/8"M. x 1/4"F.	11,30
900366	RS-24MF	1/4"M. x 1/2"F.	16,10
900378	RS-34MF	3/8"M. x 1/2"F.	16,80
900356	RS-43MF	1/2"M. x 3/8"F.	16,70
900390	RS-45MF	1/2"M. x 5/8"F.	19,40
900403	RS-54MF	5/8"M. x 1/2"F.	19,20

GIUNTI A SALDARE

SOLDER UNIONS



CODICE CODE	MODELLO MODEL	ATTAC. CONNECT. SAExODS(F)	LISTINO PRICE LIST €uro
900414	GSM-22F	1/4"x1/4"	4,90
900426	GSM-33F	3/8"x10mm	5,60
900438	GSM-44F	1/2"x12mm	6,60
900450	GSM-55F	5/8"x16mm	8,00
900462	GSM-66F	3/4"x18mm	12,00

CAPPUCCI IN RAME (*)

COPPER CAPS (*)



CODICE CODE	MODELLO MODEL	ATTAC. CONNECT. x SAE	LISTINO PRICE LIST €uro
900474	CR-2	1/4"	0,50
900486	CR-3	3/8"	0,50
900498	CR-4	1/2"	0,60
900510	CR-5	5/8"	0,60
900522	CR-6	3/4"	0,90
900534	CR-7	7/8"	1,80

RUBINETTI E VALVOLE IN OTTONE

BRASS VALVES

RUBINETTI A CAPPELLOTTO

CAP VALVES



CODICE CODE	MODELLO MODEL	ATTACCHI CONNECTIONS	LISTINO PRICE LIST €uro
901036	RC-2	1/4"SAE	37,20
901037	RC-3	3/8"SAE	37,20
901042	RC-4	1/2"SAE	38,90
901047	RC-5	5/8"SAE	40,50
901052	RC-6	3/4"SAE	75,80
901057	RC-2S	1/4"ODS	37,20
901062	RC-3S	3/8"ODS	37,20
901067	RC-M10S	10mm	37,20
901072	RC-M12S	12mm	38,90
901077	RC-4S	1/2"ODS	38,90
901082	RC-5S	5/8"ODS	40,50
901087	RC-M18S	18mm	75,80
901092	RC-6S	3/4"ODS	75,80

VALVOLE DI RITEGNO

CHECK VALVES



CODICE CODE	MODELLO MODEL	ATTACCHI CONNECTIONS	LISTINO PRICE LIST €uro
380420	CV3/M10	10 MM. ODS	40,20
380421	CV3/M12	12 MM. ODS	40,20
380422	CV3/5	5/8 ODS	48,70
380423	CV3/M18	18 MM. ODS	54,60

VALVOLE DI RITEGNO CV2/4

CV2-4 CHECK VALVES



CODICE CODE	MODELLO MODEL	ATTACCHI CONNECTIONS	LISTINO PRICE LIST €uro
380410	CV2/7	7/8"ods (22mm)	82,90
380411	CV2/9	1.1/8"ods (28mm)	82,90
380412	CV2/11	1.3/8"ods (35mm)	124,40
380414	CV2/M42	42 MM.	211,10

attacchi con tronchetto rame

380400	CV4/7	7/8"ods (22mm)	103,80
380401	CV4/9	1.1/8"ods (28mm)	103,80
380402	CV4/11	1.3/8"ods (35mm)	157,20

RUBINETTI PER SPLIT SYSTEM

SPLIT SYSTEM VALVES



CODICE CODE	MODELLO MODEL	ATTACCHI CONNECTIONS	LISTINO PRICE LIST €uro
901207	RSPL-2C	1/4"x1/4"	34,50
901217	RSPL-3C	3/8"x3/8" +ac	39,90
901222	RSPL-4C	1/2"x1/2" +ac	49,70
901227	RSPL-5C	5/8"x5/8" +ac	56,60
901228	RSPL-6C	3/4"x3/4" +ac	96,10
901229	RSPL-7C	7/8"x7/8" +ac	106,40

VALVOLE DI SICUREZZA GMC

RELIEF VALVES



CODICE CODE	MODELLO MODEL	ATTACCHI CONNECTIONS	LISTINO PRICE LIST €uro
380300	SV1/24	1/4"npt x 1/2"gas	43,70
380301	SV1/34	3/8"npt x 1/2"gas	48,80
380302	SV2/44	1/2"npt x 1/2"gas	62,60

RUBINETTO PER SERBATOIO

VALVE RECEIVER

901230	RVV2-2		14,70
--------	--------	--	-------



RUBINETTI E RACCORDI

VALVES AND FITTINGS

RUBINETTI ROTALOCK

ROVALOCK VALVES



CODICE CODE	MODELLO MODEL	ATTACCHI CONNECTIONS	LISTINO PRICE LIST Euro
901045	1UNF05	1"x5/8"SAE	24,50
901000	1UNF12	1"-12mm	23,80
901055	1UNF16	1"-16mm	25,40
901060	1UNF18	1"-18mm	25,40
901020	1-1/4UNF16	1.1/4"-16mm	30,20
901005	1-1/4UNF18	1.1/4"-18mm	30,20
901010	1-1/4UNF22	1.1/4"-22mm	43,40
901025	1-3/4UNF22	1.3/4"-22mm	48,20
901030	1-3/4UNF28	1.3/4"-28mm	67,70
901065	1-3/4UNF35	1.3/4"-35mm	68,80

RACCORDI ROTALOCK

ROVALOCK FITTINGS



CODICE CODE	MODELLO MODEL	ATTACCHI CONNECTIONS	LISTINO PRICE LIST Euro
901001	RD1UNF12	1"-12mm	13,10
901006	RD1UNF16	1"-16mm	13,60
901011	RD1UNF18	1"-18mm	15,80
901016	RD1-114-18	1.1/4"-18mm	16,30
901021	RD1-114-22	1.1/4"-22mm	18,50
901026	RD1-114-28	1.1/4"-28mm	19,60
901031	RD1-134-22	1.3/4"-22mm	24,40
901136	RD1-134-28	1.3/4"-28mm	25,00

RACCORDI ROTALOCK

ROVALOCK FITTINGS

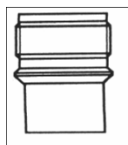

CODICE CODE	MODELLO MODEL	ATTACCHI CONNECTIONS	LISTINO PRICE LIST Euro
901002	RM1-UNF14	1"	13,10
901017	RM1-114-12	1.1/4"	23,90
901032	RM1-134-28	1.3/4"	32,50

GUARNIZIONI IN TEFLON

TEFLON GASKETS



CODICE CODE	MODELLO MODEL	ATTACCHI CONNECTIONS	LISTINO PRICE LIST Euro
901003	GUAR001	1"UNF	2,50
901008	GUAR114	1.1/4"UNF	3,00
901013	GUAR134	1.3/4"UNF	3,00

RUBINETTI A SFERA GMC

GMC BALL VALVES



CODICE CODE	MODELLO MODEL	ATTACCHI CONNECTIONS	LISTINO PRICE LIST Euro
380600	BV2-A	1/4"	46,80
380602	BVM10-A	10mm	47,90
380606	BVM12-A	12mm	47,90
380610	BV5-A	5/8"-16MM.	48,90
380612	BVM18-A	18mm	58,30
380616	BV7-A	7/8"-22mm	64,50
380618	BVM28-A	28mm	96,80
380620	BV11-A	1.3/8" - 35mm.	131,10
380622	BVM42-A	42mm	173,70
380624	BVM17-A	2"1/8 -54mm.	280,80

RUBINETTI A SFERA LINEA ECONOMICA

CHEAP BALL VALVES



CODICE CODE	MODELLO MODEL	ATTACCHI CONNECTIONS	LISTINO PRICE LIST Euro
380270	VSG6	1/4"	33,50
380271	VSG10	10mm	34,60
380272	VSG12	12mm	36,70
380273	VSG16	16mm	42,00
380274	VSG18	18mm	51,00
380275	VSG22	22mm	61,60
380276	VSG28	28mm	86,60
380277	VSG35	1.3/8"	123,20
380278	VSG42-1.5/8"	42mm	183,60
380279	VSG54	54mm	313,60

RACCORDERIA IN RAME A SALDARE

COPPER SOLDER FITTINGS

CURVE RAME 90° FxF

90° FxF COPPER BENDS



CODICE CODE	MODELLO MODEL	ATTACCHI CONNECT.	LISTINO PRICE LIST
		mm	€uro
900010	CU90FFD6	6x6	2,50
900016	CU90FFD8	8x8	2,50
900022	CU90FFD10	10x10	0,93
900028	CU90FFD12	12x12	0,76
900034	CU90FFD14	14x14	1,17
900040	CU90FFD16	16x16	1,23
900046	CU90FFD18	18x18	1,56
900052	CU90FFD22	22x22	2,30
900058	CU90FFD28	28x28	3,52
900064	CU90FFD35	35x35	8,63
900070	CU90FFD42	42x42	15,18
900076	CU90FFD54	54x54	27,84

CURVE RAME 90° MxF

90° MxF COPPER BENDS

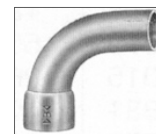

CODICE CODE	MODELLO MODEL	ATTACCHI CONNECT.	LISTINO PRICE LIST
		mm	€uro
900011	CU90MFD6	6x6	3,00
900017	CU90MFD8	8x8	3,00
900023	CU90MFD10	10x10	2,50
900029	CU90MFD12	12x12	0,89
900035	CU90MFD14	14x14	1,32
900041	CU90MFD16	16x16	1,19
900047	CU90MFD18	18x18	1,75
900053	CU90MFD22	22x22	2,60
900059	CU90MFD28	28x28	4,24
900065	CU90MFD35	35x35	10,14
900071	CU90MFD42	42x42	15,29
900077	CU90MFD54	54x54	27,81

CURVE RAME 45° FxF

45° FxF COPPER BENDS

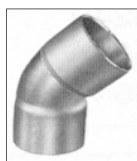

CODICE CODE	MODELLO MODEL	ATTACCHI CONNECT.	LISTINO PRICE LIST
		mm	€uro
900012	CU45FFD6	6x6	5,00
900018	CU45FFD8	8x8	5,00
900024	CU45FFD10	10x10	1,40
900030	CU45FFD12	12x12	0,87
900036	CU45FFD14	14x14	0,93
900042	CU45FFD16	16x16	0,95
900048	CU45FFD18	18x18	1,13
900054	CU45FFD22	22x22	2,12
900060	CU45FFD28	28x28	2,94
900066	CU45FFD35	35x35	7,31
900072	CU45FFD42	42x42	10,88
900078	CU45FFD54	54x54	15,70

CURVE RAME 45° MxF

45° MxF COPPER BENDS



CODICE CODE	MODELLO MODEL	ATTACCHI CONNECT.	LISTINO PRICE LIST
		mm	€uro
900019	CU45MFD8	8x8	5,00
900025	CU45MFD10	10x10	5,00
900031	CU45MFD12	12x12	1,26
900037	CU45MFD14	14x14	0,95
900043	CU45MFD16	16x16	0,95
900049	CU45MFD18	18x18	1,19
900055	CU45MFD22	22x22	2,12
900061	CU45MFD28	28x28	2,98
900067	CU45MFD35	35x35	7,42
900073	CU45MFD42	42x42	10,88

RACCORDERIA IN RAME A SALDARE

COPPER SOLDER FITTINGS

MANICOTTI RAME Fx F

Fx F COPPER COUPLINGS



CODICE CODE	MODELLO MODEL	ATTACCHI CONNECT. mm	LISTINO PRICE LIST €uro
900085	MAFFD6	6x6	1,10
900092	MAFFD8	8x8	1,13
900099	MAFFD10	10x10	0,37
900106	MAFFD12	12x12	0,47
900113	MAFFD14	14x14	0,54
900120	MAFFD16	16x16	0,67
900127	MAFFD18	18x18	0,78
900134	MAFFD22	22x22	1,99
900141	MAFFD28	28x28	2,84
900148	MAFFD35	35x35	8,36
900155	MAFFD42	42x42	13,41
900162	MAFFD54	54x54	22,16

MANICOTTI RAME RIDOTTI Mx F

Mx F REDUCING COPPER COUPLINGS



CODICE CODE	MODELLO MODEL	ATTACCHI CONNECT. mm	LISTINO PRICE LIST €uro
900091	MAMFR 08-06	8x6	1,13
900098	MAMFR 10-06	10x6	3,00
900105	MAMFR 10-08	10x8	1,94
900112	MAMFR 12-08	12x8	1,94
900119	MAMFR 12-10	12x10	2,25
900126	MAMFR 14-10	14x10	1,88
900133	MAMFR 14-12	14x12	1,16
900140	MAMFR 16-10	16x10	1,57
900147	MAMFR 16-12	16x12	1,57
900154	MAMFR 16-14	16x14	1,57
900161	MAMFR 18-12	18x12	1,84
900168	MAMFR 18-14	18x14	1,81
900175	MAMFR 18-16	18x16	1,94
900182	MAMFR 22-14	22x14	2,86
900189	MAMFR 22-16	22x16	1,95
900196	MAMFR 22-18	22x18	2,25
900203	MAMFR 28-12	28x12	4,71
900210	MAMFR 28-14	28x14	3,61
900217	MAMFR 28-16	28x16	3,65
900224	MAMFR 28-18	28x18	3,65
900231	MAMFR 28-22	28x22	3,31
900238	MAMFR 35-18	35x18	8,59
900245	MAMFR 35-22	35x22	7,91
900252	MAMFR 35-28	35x28	7,77
900266	MAMFR 42-28	42x28	12,00
900273	MAMFR 42-35	42x35	12,00
900280	MAMFR 54-28	54x28	22,00
900287	MAMFR 54-35	54x35	22,00
900294	MAMFR 54-42	54x42	20,00

TEE RAME Fx Fx F

Fx Fx F COPPER TEE



CODICE CODE	MODELLO MODEL	ATTACCHI CONNECT. mm	LISTINO PRICE LIST €uro
900086	TEE D6	6x6x6	3,00
900093	TEE D8	8x8x8	3,00
900100	TEE D10	10x10x10	2,50
900107	TEE D12	12x12x12	1,45
900114	TEE D14	14x14x14	1,28
900121	TEE D16	16x16x16	1,64
900128	TEE D18	18x18x18	2,49
900135	TEE D22	22x22x22	3,22
900142	TEE D28	28x28x28	5,51
900149	TEE D35	35x35x35	14,40
900156	TEE D42	42x42x42	20,50
900163	TEE D54	54x54x54	37,65

SIFONI IN RAME Fx F

Fx F COPPER SIPHONS



CODICE CODE	MODELLO MODEL	ATTACCHI CONNECT. mm	LISTINO PRICE LIST €uro
900312	SIFD12MM	12x12	24,50
900313	SIFD14MM	14x14	25,60
900314	SIFD16MM	16x16	30,80
900315	SIFD18MM	18x18	33,00
900316	SIFD22MM	22x22	40,40
900317	SIFD28MM	28x28	59,50
900318	SIFD35MM	35x35	82,90
900319	SIFD42MM	42x42	116,70
900320	SIFD54MM	54x54	226,00

GOMITI RAME 180° Fx F

180° Fx F COPPER ELBOWS



CODICE CODE	MODELLO MODEL	ATTACCHI CONNECT. mm	LISTINO PRICE LIST €uro
900321	GO180FFD12	12x12	4,26
900322	GO180FFD14	14x14	6,41
900323	GO180FFD16	16x16	6,38
900324	GO180FFD18	18x18	6,96
900325	GO180FFD22	22x22	11,76
900326	GO180FFD28	28x28	22,03
900327	GO180FFD35	35x35	39,62

REGOLATORI ELETTRONICI
ELECTRONIC REGULATORS



CODICE CODE	MODELLO MODEL	USCITE OUTPUTS	DISPLAY DISPLAY CIFRE/DIG.	CAMPO IMPIEGO RANGE °C	TENS. VOLTAGE	SONDA PROBE	DIMENS. DIMENSIONS mm H x L x P	LISTINO PRICE LIST Euro
----------------	------------------	-------------------	----------------------------------	------------------------------	------------------	----------------	--	-------------------------------

REGOLATORI DI TEMPERATURA / TEMPERATURE REGULATORS

123101	ICPLUS 915	2	3	-50/+140	12/24V	1xPTC/NTC	32x74x60	133,00
123025	DR 40-20	2	3	-50/+140	95/240V	1xPTC/NTC	61,6x70,2x67	147,10

CONTROLLORI PER REFRIGERAZIONE MULTIFUNZIONE / REFRIGERATION CONTROLLERS

123092	ID PLUS-961-HP2 12V	1	2,00	-50/+140	12V	1 + (1) xPTC- NTC/PT1000	32x74x60	92,50
123003	ID PLUS-961-HP2 230V	1	2,00	-50/+140	230V	1 + (1) xPTC- NTC/PT1000	32x74x60	85,20
123094	ID PLUS-971-HP2 12V	2	3,00	-50/+140	12V	2 + (1) xPTC- NTC/PT1000	32x74x60	121,90
123001	ID PLUS-971-HP2 230v	2	3,00	-50/+140	230v	1xPTC/NTC PT1000	32x74x60	113,00
123093	ID PLUS-974-HP2 12v	2	3,00	-50/+140	12v	2 + (1) xPTC- NTC/PT1000	32x74x60	119,50
123091	ID PLUS-974-HP2 230v	2	3,00	-50/+140	230v	2 + (1) xPTC- NTC/PT1000	32x74x60	119,90
123082	ID-985-LX/CK	2	3	-50/+140	12V	2xPTC/NTC	32x74x60	160,90
123097	ID-978-PLUS-HP2	2	3,00	-50/+140	230v	2 + (1) xPTC-	32x74x60	131,50
123085	EWDR-985/LX CS	3	3	-50/+140	230v	2xPTC/NTC *	70x85x61 DIN	217,60
123086	IWC-750	5	3	-50/+140	230v	2xPTC/NTC	180x37x69	176,60
123095	IWC-730	3	3	-50/+140	230v	2xPTC/NTC	180x37x48	146,60

CONTROLLORI PER REFRIGERAZIONE MULTIFUNZIONE PEGO
PEGO REFRIGERATION CONTROLLERS



NANO97412V	EXP.NANO CF3	2	3,00	-50/+140	12v	2 + NTC	32x74x60	104,80
NANO974220V	EXP.NANO CF3	2	3,00	-50/+140	230V	2 + NTC	32x74x60	109,80
NANO96112V	EXP.NANO CF1	1	2,00	-50/+140	12v	1 + NTC	32x74x60	78,00
NANO961220V	EXP.NANO CF1	1	2,00	-50/+140	230V	1 + NTC	32x74x60	83,20

NANOADAPT
NANOINT
NANOBOX



196X42,5
11X30
215X74

REGOLATORI ELETTRONICI

ELECTRONIC REGULATORS

CODICE CODE	MODELLO MODEL	DESCRIZIONE DESCRIPTION	LISTINO PRICE LIST Euro
----------------	------------------	----------------------------	-------------------------------

PRODOTTI VARI / OTHER PRODUCTS

123034	FASEC-33 230v	regolatore di velocità per condensazione - n°1 ing. per sonda PTC - 2,5A <i>condensating fan speed control - nr.1 PTC probe - 2,5A</i>	88,90
123036	FASEC-43 230v	regolatore di velocità per evaporazione - n°1 ing. per sonda PTC - 2,5A <i>evaporating fan speed control - nr.1 PTC probe - 2,5A</i>	88,90
123038	FASEC-53 230v	regolatore di velocità manuale - 2,5A <i>manual fan speed control - 2,5A</i>	95,20

ACCESSORI / ACCESSORIES

123042	PTC (N)	sonda PTC con cavo in PVC da 1,5mt / PTC probe with 1,5mt PVC cable	9,10
123044	PTC (S) 1,5m	sonda PTC con cavo in silicone da 1,5mt / PTC probe with 1,5mt silicone cable	11,60
123045	PTC (S) 3m	sonda PTC con cavo in silicone da 3mt / PTC probe with 3mt silicone cable	15,80
123046	PTC (S) 6m	sonda PTC con cavo in silicone da 6mt / PTC probe with 6mt silicone cable	23,70
123047	PTC (S) 10m	sonda PTC con cavo in silicone da 10mt / PTC probe with 10mt silicone cable	34,80
123048	NTC (S) 1,5m	sonda NTC con cavo in silicone da 1,5mt / NTC probe with 1,5mt silicone cable	11,60
123049	NTC (S) 3m	sonda NTC con cavo in silicone da 3mt / NTC probe with 3mt silicone cable	15,80
123051	NTC (S) 6m	sonda NTC con cavo in silicone da 6mt / NTC probe with 6mt silicone cable	23,70
123080	PT100 (N) V	sonda PT100 cavo in vetrorex da 3mt / PT100 probe with 3mt vetrorex cable	51,10
123081	PT100 6x150(Inf.)	sonda PT100 con cavo in silicone da 3mt / PT100 probe with 3mt silicone cable	68,40
123052	EWHS-310	sonda umidità/temperat. 20-90% -10/-70°C / humidity/temperat. probe	469,70
123054	TRA 220/12	trasformatore 220/12Vac / transformer 220/12vac	9,10
123040	EW-BOX	scatola vuota in plastica per esterno cella / plastic box for regulators	35,50
123041	INOXBOX	scatola vuota in acciaio inox per esterno cella / Inox box for regulators	86,00
123058	INTELIWEL	interruttore bipolare per EW-BOX / 2 poles switch for ew-box	4,90
123060	LAMPEL	lampadina per EW-BOX / bulb for ew-box	3,70
123053	SONDA X FASEC	sonda PTC per regolatore FASEC / PTC probe for FASEC regulator	11,60
123056	ZOCCOLO OCTAL	connettore DIN per FASEC / FASEC connector adapter	6,40
123062	ELICAVO X IS	cavetto per SLAVE per IS-972 / SLAVE cable for IS-972	10,60
123057	POZZETTO 3/8" gas	pozzetto per sonde 3/8" gas / tank for 3/8" GAS probe	13,30
123059	POZZETTO 1/2" gas	pozzetto per sonde 1/2" gas / tank for 1/2" GAS probe	19,00
123088	EWPA007	TRASDUTTORE 4-20MA -05+7BAR / pressure trasductor	181,90
123089	EWPA030	TRASDUTTORE 4-20MA -0+30BAR / pressure trasductor	181,90



FASEC-33

eliwell



EWBOX



TRA 220/12



PTC (N)10

QUADRI ELETTRICI PEGO

PEGO ELECTRICAL BOARDS



CODICE MODELLO
CODE MODEL

DESCRIZIONE
DESCRIPTION

LISTINO
PRICE LIST
Euro

QUADRI ELETTRICI INTEGRAL CONTROLLER / INTEGRAL CONTROLLER ELECTRICAL BOARDS

123551 ECP200-EXPERT
completo di 2 sonde
with 2 probes



integral controller per impianti monofase fino a 2HP completo di protezione magnetotermica: per la gestione di unità statiche o ventilate, comando resistenze di sbrinamento, luce cella, ventilatori evaporatore e comando ausiliario.
Integral controller for 2HP single phase refrigerant equipped with thermic breaker protection: for static or ventilated refrigerating units that allow to protect defrosting heaters, evaporator fans, cold room light and auxiliary control.

296,50

123507 ECP200-EXPERT-D 7,5
completo di 2 sonde
with 2 probes

integral controller per impianti monofase fino a 2HP per la gestione di unità statiche o ventilate, comando resistenze di sbrinamento (max2,5kw/fase), luce cella, ventilatori evaporatore e comando ausiliario.
Integral controller for 2HP single phase refrigerant for static or ventilated refrigerating units- with 3ph defrost contactor - that allow to protect defrosting heaters, evaporator fans, cold room light and auxiliary control.

323,70



QUADRO ELETTRICO FRONTE CELLA / EXTERNAL COLD ROOM ELECTRICAL BOARD

123554 ECP200-BASE-2/A
completo di 1 sonda
with 1 probe

fronte cella per impianti monofase fino a 2HP per la gestione completa di unità statiche, con sbrinamento a sosta, luce cella da interfacciare a quadro di potenza / *electrical board for 2HP single phase refrigerant equipped for static refrigerating units, cold room light, without electric defrost*

249,00

123552 ECP200-BASE-4/A
completo di 2 sonde
with 2 probes

fronte cella per impianti monofase fino a 2HP per la gestione completa di unità statiche o ventilate, con sbrinamento elettrico o a sosta, luce cella, ventilatori evaporatore / *electrical board for 2HP single phase refrigerant equipped for static or ventilated refrigerating units that allow to protect defrosting heaters, evaporator fans e cold room light.*

271,60

QUADRI ELETTRICI INTEGRAL CONTROLLER / INTEGRAL CONTROLLER ELECTRICAL BOARDS



123555 ECP300-B4VD

RELAYS TERMICI SUGGERITI			
HP 1,0: 1,6 / 2,5A	HP 1,5: 2,5 / 4A	HP 2,0: 4,0 / 6A	HP 3,0: 5,5 / 8A
HP 4,0: 7 / 10A	HP 5,0: 9 / 13A	HP 7: 12 / 18A	HP 7,5-10: 17/ 25A

quadro per impianto frigorifero trifase, fino a 3HP, ventilato, sbrin.elettrico elettronica PEGO / *electrical board for three-phase refrigerating plant, up to 3HP, ventil. electrical defrost-PEGO ELECRTONIC CONTROL*

628,10

123567 ECP750-B4VD

quadro per impianto frigorifero trifase, fino a 7,5HP, ventilato, sbrin.elettrico elettronica PEGO / *electrical board for three-phase refrigerating plant, up to 7,5HP, ventil. electrical defrost-PEGO ELECRTONIC CONTROL*

1.006,20



123570 ECP-APE03

KIT ALLARME UOMO IN CELLA- CENTRALINA C/SEGNALE ACUSTICO/VISIVO

KIT ALLARME UOMO IN CELLA- CENTRALINA C/SEGNALE ACUSTICO/VISIVO
MAN IN COLD ROOM ALLARM

323,60

QUADRI ELETTRICI PEGO



PEGO ELECTRICAL BOARDS

CODICE CODE	MODELLO MODEL	DESCRIZIONE DESCRIPTION	LISTINO PRICE LIST Euro
----------------	------------------	----------------------------	-------------------------------

QUADRI ELETTRICI INTEGRAL CONTROLLER / INTEGRAL CONTROLLER ELECTRICAL BOARDS

123559	ECP300-EXPERT-VD3	FINO A 3HP MAX 8A / UP TO 3HP MAX 4A	699,50
123561	ECP300-EXPERT-VD4	FINO A 4HP MAX 12A / UP TO 4HP MAX 12A	954,80
123562	ECP300-EXPERT-VD7	FINO A 7,5HP MAX 20A / UP TO 7,5HP MAX 20A	1.195,80

integral controllers impianti TRIFASE compl.di protez. magnetotermica e salvamotore per la gestione di unità statiche o ventilate, comando resistenze di sbrinamento luce cella, ventilatori evaporatore e comando ausiliario.
Integral controller three phase refrigerant equipped with thermic breaker and overload protector for static or ventilated refrigerating units that allow to protect defrosting heaters, evaporator fans, cold room light and auxiliary control.

QUADRI ELETTRICI DI POTENZA E DA ABBINARE A CONTROLLO REMOTO

PEGO POWER BOARDS



123509E	ECP04 -TERM ELETT.	quadro potenza trifase fino a max. 3,3HP- termica 3-12A- res. Carter electrical board for three-phase unit up to 3,3HP 3-12A	339,40
123526	ECP07	quadro di comando e protezione per unità trifase fino a max. 7HP electrical board for three-phase condensing unit up to 7HP	429,90



PLAFONIERA PER CELLE FRIGORIFERE EXPERT LED IDONEA PER TEMPERATURE NEGATIVE

PEGO EXPERTLED COLD ROOM & FREEZER LIGHT

LED- LIGHT30	EXPERT LED 30	PLAFONIERA A LED PER CELLA 700 LUMEN/ 8W - 230 v - mm.419x93x36 1600 Lumen/16w led light for cold room - mm. 665x93x36	130,00
LED- LIGHT60	EXPERT LED 60	PLAFONIERA A LED PER CELLA 1570 LUMEN/ 16,5W - 230 v - mm.665x93x36 1600 Lumen/16w led light for cold room - mm. 665x93x36	158,30
LED- LIGHT120	EXPERT LED 120	PLAFONIERA A LED PER CELLA 3250 LUMEN /32,5W - 230 v - mm.1157x93x36 3200 Lumen/16w led light for cold room - mm. 1157x93x36	252,70



COMBINATORE TELEFONICO GSM / GSM ALLARM MODULE

123575	EXPERT200GSMB	COMBINATORE TELEFONICO GSM PER ALLARMI GSM ALLARM MODULE	241,30
--------	---------------	---	--------



REGISTRATORI DI TEMPERATURA / TEMPERATURE RECORDERS

123568	PLUS EXPERT DL3	regisrat. a 3 canali con possibilità di visualizzare direttamente con scarico dati tramite porta USB	550,30
123569	PLUS EXPERT DL8	regisrat. a 8 canali con possibilità di visualizzare direttamente con scarico dati tramite porta USB 3 OR 8 channelS temp.recorder wich allows recorded temperatures to be displayed directly on the screen,or recorded on USB PORT	687,60

COMPONENTI ED ATTREZZATURE PER R744 (CO2)

R744 (CO2) EQUIPMENTS AND COMPONENTS

RUBINETTI A SFERA PER R744 - (CO2) 120 BAR CON ATTACCO DI CARICA

R744 (CO2) 120 BAR BALL VALVES

LISTINO
PRICE LIST
€uro

380280	RUBF.SFERA R744-120 BAR	DIAM. 06mm. - 06mm R744 ball valve 120 bar
380281	RUBF.SFERA R744-120 BAR	DIAM. 10mm. - 10mm R744 ball valve 120 bar
380282	RUBF.SFERA R744-120 BAR	DIAM. 12mm. - 12mm R744 ball valve 120 bar
380283	RUBF.SFERA R744-120 BAR	DIAM. 16mm. - 16mm R744 ball valve 120 bar
380284	RUBF.SFERA R744-120 BAR	DIAM. 18mm. - 18mm R744 ball valve 120 bar
380285	RUBF.SFERA R744-120 BAR	DIAM. 22mm. - 22mm R744 ball valve 120 bar
380286	RUBF.SFERA R744-120 BAR	DIAM. 28mm. - 28mm R744 ball valve 120 bar
380287	RUBF.SFERA R744-120 BAR	DIAM. 35mm. - 35mm R744 ball valve 120 bar
380288	RUBF.SFERA R744-120 BAR	DIAM. 42mm. - 42mm R744 ball valve 120 bar



88,70
129,50
178,30
238,80
255,80
249,40
273,80
357,70
577,30

RUBINETTI A SFERA PER R744 - (CO2) 60 BAR - GMC

GMC R744 (CO2) 60 BAR BALL VALVES

LISTINO
PRICE LIST

380250C	RUBF.SFERA R744-60 BAR	DIAM. 06mm. - 06mm R744 ball valve 60 bar
380252C	RUBF.SFERA R744-60 BAR	DIAM. 10mm. - 10mm R744 ball valve 60 bar
380253C	RUBF.SFERA R744-60 BAR	DIAM. 12mm. - 12mm R744 ball valve 60 bar
380255C	RUBF.SFERA R744-60 BAR	DIAM. 16mm. - 16mm R744 ball valve 60 bar
380259C	RUBF.SFERA R744-60 BAR	DIAM. 22mm. - 22mm R744 ball valve 60 bar
380261C	RUBF.SFERA R744-60 BAR	DIAM. 28mm. - 28mm R744 ball valve 60 bar
380263C	RUBF.SFERA R744-60 BAR	DIAM. 35mm. - 35mm R744 ball valve 60 bar



50,30
53,60
51,50
58,60
81,40
112,90
157,00

ATTREZZATURE PER R744 (CO2)

R744 (CO2) EQUIPMENTS

CODICE CODE	MODELLO MODEL	DESCRIZIONE DESCRIPTION
704500	PF2ML/D5-4/K1	GRUPPO MANOMETRICO 2 VIE DIAM. 80 PER R744 R744- 2 WAY MANIFOLD
704510	3COSS4-4-60	SERIE 3 TUBI DI CARICA PER R744 - MM. 1500 mm. 1500 kit of 3 flexible hoses
704502	816/2	RIDUZIONE PER BOMBOLA R744 CO2 BOTTLE ADAPTER
704512	D-TEK SELECT	706-202-G11 - CERCAFUGHE ELETTRONICO PER R744 706-202-G11 D-TEK- R744 LEAK DETECTOR



LISTINO
PRICE LIST
€uro

345,20
203,00
11,00
1.444,80

RIDUTTORE AZOTO (0-200BAR) PER IMPIANTI R744 (CO2)

NITROGEN REGULATOR (0-200BAR) FOR R744 SYSTEMS

CODICE CODE	MODELLO MODEL	DESCRIZIONE DESCRIPTION
704504	AZ200-200	RIDUTT. AZOTO (0-200BAR) PER IMP. R744 (CO2) NITROGEN REGULATOR (0-200BAR) FOR R744 SYSTEMS
704506	48F4-(U1-48)	RIDUZIONE 1/4 SAE PER ZZ200-200 / 1/4SAE ADAPTER FOR AZ200-200
704508	COSS/4-4-60V8- PF80/N2-K1	KIT DI ESECUZIONE TEST PER IMP. R744 (CO2) R744 (CO2) - TEST SYSTEM KIT



570,00
6,20

256,00

SISTEMI DI RECUPERO GAS REFRIGERANTI

REFRIGERANT RECOVERY EQUIPMENTS

UNITA' PORTATILE PER IL TRASFERIMENTO DI REFRIGERANTE CON COMPRESSORE A SECCO

PORTABLE UNIT FOR REFRIGERANT TRANSFER - OIL-LESS COMPRESSOR

dimensioni / dimensions 406x250x222mm

alimentazione / power supply 220/1/50

peso / weight 10,5kg

velocità di rec. / recovery rate fino a / up to 240kg/h - push-pull

fino a / up to 17kg/h - vapore / vapor

fino a / up to 50kg/h - liquido / liquid

CODICE CODE	MODELLO MODEL	DESCRIZIONE DESCRIPTION
703106	MINIMAX	unità portatile per tutti refrigeranti / portable unit for all refrigerant



LISTINO
PRICE LIST
€uro
1.701,60

UNITA' PORTATILE PER IL RECUPERO E RICICLO DI REFRIGERANTE CONFORMI NORMATIVE ISO 11650 - NF EN 354-21

PORTABLE UNIT FOR RECOVERY AND RECYCLING REFRIGERANT

703111R	EASYREC 1 - R	unità portatile di recupero e riciclo con distillatore portable unit for all refrigerants with distiller dimensioni / dimensions 545x300x395mm - kg. 18,90
703109R	EASYREC 2 - R	unità portatile di recupero e riciclo con distillatore portable unit for all refrigerants with distiller dimensioni / dimensions 545x300x395mm - kg. 16,60



2.439,00

3.110,00

VELOCITA' DI RECUPERO:	VAPORE	LIQUIDO	LIQUIDO	PUSH-PULL
Recovery rate		(recupero)	(rec.+ricicl.)	
ESYREC 1 -R	14-16 kg./h	96-132 Kg./h	16-18 Kg./h	276-378 Kg.h
ESYREC 2 -R	28-32 kg./h	168-198 Kg./h	32-36 Kg./h	450-570 Kg.h

CONTROLLO PERDITE MESSA IN PRESSIONE IMPIANTI

LEAKS TESTING AND PRESSURE CONTROL

CODICE CODE	MODELLO MODEL	DESCRIZIONE DESCRIPTION
703116	K-AZ200-50/BAZ50	kit azoto 5lt. / 5lt. nitrogen kit
703119	V/WSA71M-4/6Y/ PF80/N2-K1	man azoto c/tubo. / nitrogen kit
703123	AZ-200-50	ridutt. Azoto AZ200-50 / Nitr. Gauge
703114	K-AZ200-50/BAZ50	kit azoto 950CC / 950 cc nitrogen kit
703117	BN2/1-TPED	bomb. azoto 0,001 mc. / 0,001 mc. nitrogen dispasable



LISTINO
PRICE LIST
€uro

1.059,50

102,10

329,70

554,40

42,30

LAVAGGIO E BONIFICA TUBAZIONI

FLUSHING SYSTEM

CODICE CODE	MODELLO MODEL	DESCRIZIONE DESCRIPTION
703115	FLASH-FLUSH FORMULA	KIT DI LAVAGGIO FLUSHING KIT
703121	SUPERFLUSH/6	FLUIDO LAVAGGIO CONF . KG.6,00 FLUSHING FLUID CAP. KG. 6,00



56,60



126,60

pg.61

SANIFICANTI E DETERGENTI



CHEMICALS

PRODOTTI PER LA PULIZIA / PRODUCTS FOR CLEANING

703126	CONDIBAT	sanificante, deodorante e battericida conf. da 0,65		42,50
SPRAYDET	CLIMAFOAM	sanificante schiumogeno conf. da 650 ml		26,80
703127	HYGIEN SPRAY	disinfettante multiuso conf. da 150ml		27,30
703125	HYGIEN TABLETS	sanificante in pastiglie conf. 200 pz.		133,00
703132	CLEAN-AIR	sanificante,deodorante conf. 0,4		17,90
CARLYBIO500	BIO 500	DISINFETT. PER BATTERIE VAPORIZZ. 500 ML		26,80
CARLYBIO5000	BIO 5000	DISINFETT. PER BATTERIE FUSTINO 5 LT.		156,60
CARLYCLEAN-F	CLEAN F	DETERGENTE IN SCHIUMA PER BATTERIE		30,40
CARLYCLEAN-25	CLEAN 25	DETERGENTE IN SCHIUMA PER BATTERIE LT. 25		341,00

RESISTENZE ELETTRICHE E VASCHE ASCIUGACONDENSA

HEATING CABLES AND EVAPORATING WATER TRAYS

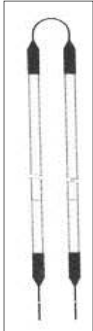
CODICE CODE	MODELLO MODEL	DESCRIZIONE DESCRIPTION		LISTINO PRICE LIST €uro
RESISTENZE DI SCARICO / heating cable for discharge - tensione / voltage 220V				
040896	FLEX100 - 1m	calza in acciaio inox / stainless steel cable		17,60
040898	FLEX200 - 2m	calza in acciaio inox / stainless steel cable		20,70
040900	FLEX300 - 3m	calza in acciaio inox / stainless steel cable		24,90
040905	FLEX500 - 5m	calza in acciaio inox / stainless steel cable		32,10
040906	FLEX600 - 6m	calza in acciaio inox / stainless steel cable		35,20
040910	FLEX800 - 8m	calza in acciaio inox / stainless steel cable		50,80
040917	SIL2M - 2m	silicone monocavo / mono-cable silicone		27,00
040916	SIL3M - 3m	silicone monocavo / mono-cable silicone		31,10
040918	SIL4M - 4m	silicone monocavo / mono-cable silicone		35,20
040911	SIL5M - 5m	silicone monocavo / mono-cable silicone		38,30
040912	SIL6M - 6m	silicone monocavo / mono-cable silicone		43,50
040919	SIL8M - 8m	silicone monocavo / mono-cable silicone		55,90
040913	SIL10M - 10m	silicone monocavo / mono-cable silicone		62,10
CAVI RISCALDANTI PER PORTE E VETRINE / heating cable for doors and cabinets				
040915	SILIC100	resistenza per porta / heating cable for door 220V	prezzo/price mt	10,40
040920	SILIC101	resistenza per porta / heating cable for door 24V	prezzo/price mt	11,40
RESISTENZE DOPPIE RETTILINEE PER EVAPORATORI E BACINELLE / double straight heating cable				
040924	RES040	lunghezza / length 400mm - 260W / 115+115V		56,20
040925	RES050	lunghezza / length 500mm - 400W / 115+115V		60,40
040926	RES070	lunghezza / length 700mm - 460W / 115+115V		67,60
040927	RES080	lunghezza / length 800mm - 500W / 115+115V		70,80
040930	RES0100	lunghezza / length 1.000mm - 660W / 115+115V		78,00
040935	RES0150	lunghezza / length 1.500mm - 1.100W / 115+115V		102,00
040936	RES0170	lunghezza / length 1.700mm - 1.400W / 115+115V		121,70
040940	RES0210	lunghezza / length 2.100mm - 1.650W / 115+115V		146,70
040941	RES0230	lunghezza / length 2.300mm - 1,750W / 115+115V		147,70
040945	RES0255	lunghezza / length 2.550mm - 2.150W / 115+115V		169,60
040946	RES0270	lunghezza / length 2,700mm - 2.400W / 115+115V		173,70
040950	RES0300	lunghezza / length 3.000mm - 2.600W / 115+115V		178,50
040952	RES0330	lunghezza / length 3.300mm - 2.790W / 115+115V		215,00

VASCHE ASCIUGACONDENSA CON TERMOSTATO MECCANICO / aluminium evaporating water trays

041000	V000010	dimensioni / dimensions 470 x 150 x 100	226,10
--------	---------	---	--------

ATTREZZATURA PER IMPIANTI SPLIT CON REFRIGERANTE R410A - R32

SPLIT-SYSTEM EQUIPMENT WITH R410A / R32 REFRIGERANT

BILANCE ELETTRONICHE / ELECTRONIC SCALES

CODICE <i>CODE</i>	MODELLO <i>MODEL</i>	DATI TECNICI <i>TECHNICAL DATA</i>	LISTINO <i>PRICE LIST</i> €uro
703112	ADS100	 <p>display a 3 visualizzazioni / <i>three display mode</i> lbs/oz-lbs-kg peso massimo / <i>maximum weight</i> 100kg risoluzione / <i>resolution</i> 0,04kg precisione / <i>accuracy</i> +- 0,5% del valore / of reading alimentazione 1 batteria 9V / <i>power supply</i> 1x9V alkaline battery</p>	621,00
703110	TIF9010A	 <p>display a 3 visualizzazioni / <i>three display mode</i> lbs/oz-lbs-kg peso massimo / <i>maximum weight</i> 50kg risoluzione / <i>resolution</i> 2g precisione / <i>accuracy</i> +- 0,5% del valore / of reading alimentazione 1 batteria 9V / <i>power supply</i> 1x9V alkaline battery</p>	446,00
702098	WP8-DE/V	pompa da vuoto 2-stadi / <i>2-stage high vacuum pump</i> 128 lt/min.	755,30
702073	RS3-DE/V	pompa da vuoto 2-stadi / <i>2-stage high vacuum pump</i> 42 lt/min.	682,40
703089	TIF XP1A	cercafughe elettronico / <i>electronic leak detector</i>	599,00
703054	TW/KIT	set chiavi dinamometriche / <i>complete wrenches kit</i> 17-22-24-26-27- 29	128,10
702009	W4PF80/A4/5-k1	gruppo manometrico a 4 vie / <i>4-way manifold diam.80mm</i>	164,60
702149	GYSA/5-5/56V4	tubazione flessibile / <i>flexible hose</i> 1,5mt.	51,00
900405	RS-2F516M	riduzione 5/16"SAEM.x1/4"SAE F./ <i>reducing fitting 5/16"SAE M.x1/4"SAE F.</i>	8,70

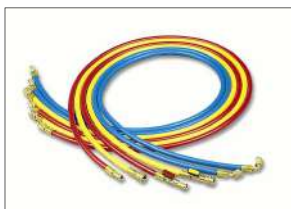

PREZZI NETTI CERTIFICAZIONI DI CALIBRATURA

CERTIFICATES: NET PRICE

CALIBR-BIL	CERTIFICATO DI CALIBRAZIONE BILANCIA	netto	110,00
CALIBR-CERC	CERTIFICATO DI CALIBRAZIONE CERCAFUGHE	netto	80,00
CALIBR-GRUP	CERTIFICATO DI CALIBRAZIONE GRUPPO MANOMETRICO	netto	110,00
CALIBR-MAN-	CERTIFICATO DI CALIBRAZIONE GR. MAN. DIGITALE	netto	169,00
CALIBR-PINZAMP	CERTIFICATO DI CALIBRAZIONE MULTIMETRO /PINZA AMP.	netto	94,00
CALIBR-TERM-1S	CERTIFICATO DI CALIBRAZIONE TERMOMETRO 1 SONDA	netto	94,00
CALIBR-TERM-2S	CERTIFICATO DI CALIBRAZIONE TERMOMETRO 2SONDA	netto	147,00

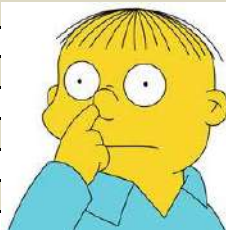

ATTREZZATURE PER IL VUOTO E LA CARICA

VACUUM AND CHARGING EQUIPMENTS

POMPE DOPPIO STADIO PER ALTO VUOTO / DOUBLE STAGE HIGH VACUUM PUMPS COMPLETE DI VALVOLA SOLENOIDE E VACUOMETRO / WITH SOLENOID VALVE AND VACUUM GAUGE



CODICE CODE	MODELLO MODEL	VUOTO FINALE ULTIMATE VACUUM mbar	ALIMENT. VOLTAGE	PORTATA SWEPT VOLUME l/min	PESO WEIGHT kg	LISTINO PRICE LIST Euro
702073	RS3D EV	1x10 ⁻²	220/1/50	42	7,5	682,40
702098	WP8/D E/V	1x10 ⁻²	220/1/50	128	12,4	755,30
702074	RS-9D E/V	1x10 ⁻²	220/1/50	180	12,5	1.220,80
702082	RS-15DE	1x10 ⁻²	220/1/50	250	17	1.856,20
702087	K-EVC	KIT SOLENOIDE E VACUOMETRO / VACUUM GAUGE & SOLENOID KIT				136,50
702089	SW68 1lt.	OLIO SINTETICO POE / SYNTETIC POE OIL				63,00
702091	K1L 1lt.	OLIO MINERALE / MINERAL OIL				22,60

GRUPPI MANOMETRICI / MANIFOLDS

CODICE CODE	MODELLO MODEL	DIAMETRO DIAMETER mm	REFRIG. REFRIG.	ATTACCHI CONNECT.	LISTINO PRICE LIST Euro
A 4 VIE / 4-ways					
702003	W4PF80/A6/4/K1	80	R22-R134a-R404A-R407C	3x1/4"+1x3/8" SAE	165,30
702009	W4PF80/A4/5/K1	80	R410A	3x5/16"+1x3/8" SAE	164,60
702021	W4BL60/A6/4/K1 **	60	R22-R134a-R404A-R407C	3x1/4"+1x3/8" SAE	315,40
** in bagno d'olio / oil-filled					



702022	K-W4MSA4-5-CSA60 C/TUBI IN VALIGETTA	80	R410A - R32	3x5/16"+1x3/8" SAE	266,20
--------	---	----	-------------	--------------------	--------

A 2 VIE / 2-ways

702000	F2PF80/A6/4/K1	80	R22-R134a-R404A-R407C	3x1/4" SAE	131,70
702006	F2PF80/A4/5/K1	80	R410A	3x5/16" SAE	131,80

MANOMETRI / PRESSURE GAUGES

attacco radiale "Pulse-Free", a secco / "Pulse-Free" dry radial connection

702033	PF80/15R1/A6 BP	80	R22-R134a-R404A-R407C	1/8" NPT	36,10
702036	PF80/35R1/A6 AP	80	R22-R134a-R404A-R407C	1/8" NPT	36,10
702027	PF80/38R1/A4 BP	80	R410A	1/8" NPT	36,10
702030	PF80/53R1/A4 AP	80	R410A	1/8" NPT	36,10



RICAMBI E ACCESSORI PER GRUPPI MANOMETRICI / MANIFOLD ACCESSORIES AND SPARE PARTS

702024	VLGT-LX	VALIGETTA PER GRUPPO MAN. / CASE FOR MANIFOLD			56,00
WKG07	WKG-07 (H-L-V-R)	KIT MANOPOLA / KNOB KIT			16,30
WKG04	WKG-04	KIT GUARNIZIONI PER MANOPOLA / GASKETS KIT FOR KNOB			3,70

ATTREZZATURE PER IL VUOTO E LA CARICA

VACUUM AND CHARGING EQUIPMENTS

MANOMETRI / PRESSURE GAUGES

CODICE CODE	MODELLO MODEL	DIAMETRO DIAMETER mm	REFRIG. REFRIG.	ATTACCHI CONNECT.	LISTINO PRICE LIST €uro
attacco radiale, in bagno d'olio / radial connection, oil-filled					
702103	BLD60RBO BP	60	R22-R134a-R404A-R407C	1/8" NPT	99,70
702106	BLD60RBO AP	60	R22-R134a-R404A-R407C	1/8" NPT	99,70
attacco posteriore, in bagno d'olio / rear connection, oil-filled					
702109	BLD60CBO BP	60	R22-R134a-R404A-R407C	1/4" SAE	121,70
702112	BLD60CBO AP	60	R22-R134a-R404A-R407C	1/4" SAE	121,70
702118	STF60	staffa di fissaggio / bracket for pressure gauge			22,00
702115	M60VRC UNIV.	60	incasso/glicerina d.60mm	1/4" SAE	45,50



TUBAZIONE FLESSIBILI AD ALTA AFFIDABILITA' / HEAVY DUTY FLEXIBLE HOSES

CODICE CODE	MODELLO MODEL	ATTACCHI CONNECT.	LUNGHEZZA LENGTH mm	VERSIONE TYPE	LISTINO PRICE LIST €uro
attacchi in linea con valvola a sfera e depressore / straight connections with ball valve and valve opener					
702130	V/HDSS/4-4/60	1/4" SAE	1.500	nero / black	54,20
attacchi in linea con valvola a sfera / straight connections with ball valve					
702133	V/HDSS/6-6/60	3/8" SAE	1.500	nero / black	54,60
attacchi in linea x 45° con depressore e valvola intermedia straight connections x 45° angle with valve opener and intermediate valve					
702148	GYS/A/4-4/56V4	1/4" SAE	1.500	colorato / colored	52,00
702149	GYS/A/5-5/56V4	5/16" SAE	1.500	colorato / colored	51,00
attacchi in linea x 45° con valvola a sfera e depr. / straight connections x 45° angle with ball valve and valve opener					
702146	V/GYSA/5M-5/6 corto	5/16" SAE	150	colorato / colored	30,50
702147	V/HDSA/4M-4/6 corto	1/4" SAE	150	nero / black	102,00
kit n°3 tubi attacchi in linea x 45° con depressore / 3pcs kit hoses with straight connections x 45° angle with valve opener					
702151	3WSA/4-4/60/BRY	1/4" SAE	1.500	1 Blu / 1 Red / 1 Yel.	88,70

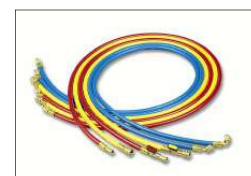

RICAMBI PER TUBAZIONI / HOSES SPARE PARTS









702154	G19020	kit n°10pz guarnizioni per tubi da 1/4"SAE / kit 10pcs gaskets for 1/4"SAE hoses			5,80
702156	G19030	kit n°10pz guarnizioni per tubi da 3/8"SAE / kit 10pcs gaskets for 3/8"SAE hoses			9,50
702155	G19516	kit n°10pz guarnizioni per tubi da 5/16"SAE / kit 10pcs gaskets for 5/16"SAE hoses			9,50
702157	D19302	kit n°10pz depressori per tubi / kit 10pcs valve openers for hoses			8,40



ATTREZZATURE PER IL VUOTO E LA CARICA



VACUUM AND CHARGING EQUIPMENTS

VALVOLE DI SERVIZIO ED ESTRATTORI / SERVICE VALVES AND CORE SCREWER TOOLS

CODICE CODE	MODELLO MODEL	ATTACCHI CONNECT.	CONFEZ. PACKAGE		LISTINO PRICE LIST Euro
700002	VS14-14	1/4" x 1/4"SAE	-		4,50
700004	VS14-6-8-10	1/4"SAE x 6-8-10mm	-		4,50
700006	VS14-06	1/4"SAE x 6mm	-		4,50
700008	VS14-18	1/4"SAE x 1/8"NPT	-		4,50
700010	VSSL100 L=100mm	1/4"SAE x 6mm	10pz/pcs		38,30
700015	VSSL10516 L=100mm	1/4"SAE x 6mm	10pz/pcs		42,80
701027	meccanismo interno / internal core				3,40
701030	cappuccio cieco / cap				3,40
700028	EW-3900	estrattore per valvola / core screwer tool			63,00
700027	A32000	cacciavite togliavalvola / core screwer tool			25,70
700026	CTV-1	cacciavite togliavalvola / core screwer tool			7,90

GIUNTI E ATTACCHI RAPIDI / QUICK COUPLINGS



raccordi dritti / straight adapters

702166	RG180	1/4"SAE maschio/male x 1/4"SAE girevole/swivel connection		11,40
702168	RG180-4/5	5/16"SAE maschio/male x 1/4"SAE girevole/swivel connection		16,80
702169	RG180F	1/4"SAE femmina/female x 1/4"SAE girevole/swivel connection		20,20
702180	QC-S410A	1/4"SAE maschio/male x 5/16"SAE fem. girevole/swivel connect.		16,90

raccordi ad angolo / angle 90° adapters

702171	RG090	1/4"SAE maschio/male x 1/4"SAE girevole/swivel connection		13,70
702172	RG090/5-4	1/4"SAE maschio/male x 5/16"SAE girevole/swivel connection		13,70

attacchi rapidi / quick coupling

702175	16-C dir.	1/4"SAE maschio/male x 1/4"SAE femmina/female		50,90
702176	17-C 90°	1/4"SAE maschio/male x 1/4"SAE femmina/female		60,00
702174	121RG4	1/4"SAE fem. gir./swivel fem. x 1/4"SAE maschio/male		27,40
702170	CA-1/2"-20UNF-Y	5/16"SAE fem. gir./swivel fem. x 5/16"SAE maschio/male		17,90

POMPE CARICA OLIO / OIL CHARGING PUMPS

700029	77940 (1)	per tutti i tipi di fusti / for all oil containers		462,90
700030	77930 (2)	per fusti fino a 5 galloni / for oil containers up to 5 gallons		577,90

ATTREZZATURE PER IL VUOTO E LA CARICA

VACUUM AND CHARGING EQUIPMENTS

CODICE CODE	MODELLO MODEL	DESCRIZIONE DESCRIPTION	LISTINO PRICE LIST €uro
----------------	------------------	----------------------------	-------------------------------

VALVOLE DI CHIUSURA PER IMPIANTI SPLIT / shut-off valve for split systems

702164	SHUT-OFF 1/4"	1/4"SAE maschio/male x 1/4"SAE femmina/female	32,00
702165	SHUT-OFF 5/16"	5/16"SAE maschio/male x 5/16"SAE femmina/female	32,00
702181	G-LV/T-WIG	conf. 5 gommini per shut off valve / shut off valve gaskets	8,20



RUBINETTI PERFORATORI / PIERCING VALVES

700022	BPV31	1/4"SAE per tubi/for tubes 6-10mm	14,60
--------	-------	-----------------------------------	-------



TUBO CAPILLARE TERMOPLASTICO / THERMOPLASTIC CAPILLARY TUBE

CODICE CODE	MODELLO MODEL	DESCRIZIONE DESCRIPTION	LISTINO PRICE LIST €uro
----------------	------------------	----------------------------	-------------------------------

905000	TCT100	conf. da 100mt di tubo capillare / 100mt package of capillary tube	646,00
--------	--------	--	--------

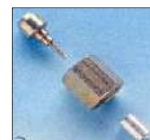

905002	WCG250	kit di n°50 raccordi diritti / kit of 50pcs straight fittings	200,30
905009	WCG210T	kit di n°10 raccordi a T / kit of 10pcs TEE fittings	175,40
905007	WCG210/90	kit di n°10 raccordi ad angolo / kit of 10pcs 90° fittings	122,40
905004	DEPREX	depressore per raccordi WCG250 / valve opener for WCG250 fittings	14,00
905006	PINZA	pinza graffatrice per tubo / crimping manual tool	413,20
905010	CUTTER	tagliatubo in plastica / plastic tube cutter	18,70



703129	LEAK-STOP	TURAFALLE / HVAC LEAK-STOP	188,00
703130	K-LS	KIT 2 CARTUCCE / RECHARGE KIT	97,70

VACUOMETRI / VACUUM GAUGES

CODICE CODE	MODELLO MODEL	DESCRIZIONE DESCRIPTION	LISTINO PRICE LIST €uro
----------------	------------------	----------------------------	-------------------------------



ED605



PF80



W3VP

702101	ED605	vacuometro digitale a batteria 9V / digital vacuum gauge - 9V alk. battery	367,00
702097	W3VPF80	0/1000 mbar, diam.80mm, attacco/connect. 1/4"x3/8"M.x3/8" F.	90,60
702094	PF80V/RI	0/1000 mbar, diam.80mm, attacco radiale /radial connect. 1/8"NPT	37,40
702094	PF80V/CI	0/1000 mbar, diam.80mm, attacco poster. / rear connect. 1/8"NPT	37,40

ATTREZZI E UTENSILI

TOOLS

FLANGIATUBI E TAGLIATUBI / FLARING TOOLS AND TUBE CUTTERS

CODICE **MODELLO** **DESCRIZIONE**
CODE MODEL DESCRIPTION



LISTINO
PRICE LIST
€uro

703014 525F per diametri / for OD tubing 5...16mm 3/16"....5/8"
703022 RF-275-FS per diametri / for OD tubing 3/16" - 1/4" - 5/16" - 3/8" - 1/2" - 5/8"

169,10
104,10

TAGLIATUBI / TUBE CUTTERS

CODICE **MODELLO** **DESCRIZIONE**
CODE MODEL DESCRIPTION



LISTINO
PRICE LIST
€uro

703006 TC1050 per diametri / for OD tubing 4...16mm (rotellina di ricambio / cutting wheel 32633) 44,10
703008 TC1000 per diametri / for OD tubing 4...28mm (rotellina di ricambio / cutting wheel 75015) 76,60
703013 312FC per diametri / for OD tubing 7...41mm (rotellina di ricambio / cutting wheel 75015) 109,00
703015 206FB per diametri / for OD tubing 10...66mm (rotellina di ricambio / cutting wheel 74761) 179,80

RICAMBI PER TAGLIATUBI / SPARE PARTS FOR TUBE CUTTERS

703052 32633 rotellina di ricambio per TC-1050 / wheel for TC-1050 12,80
703050 75015 rotellina di ricambio per TC-1000 / wheel for TC-1000 15,10
703056 750/R rotellina di ricambio per tagliatubi medio / medium size wheel 19,30

UTENSILI VARI / OTHER TOOLS

703012 208F sbavatubo / hand deburrer 52,50
703406 WS10 sbavatubo / hand deburrer 24,10
703024 RR pinza schiacciato / pinch-off plier 76,90
703060 PTC1 pinza tagliacapillare / capillary tube cutter 24,20
703062 PA6 pettini per alette / fin comb 16,90
703065 C4751/015 calibro per capillari / capillary gauge tool 0,45...1,5mm 66,10
703067 C4751/030 calibro per capillari / capillary gauge tool 1,5...3mm 66,10
703131 MAS20 sblocca bobine magnetico per elettrovalvole 63,80



RR



PTC1



PA6

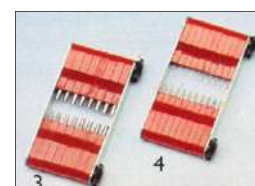

C4751

ATTREZZI E UTENSILI

TOOLS

ALLARGATUBO A LEVA / TUBE EXPANDER TOOL

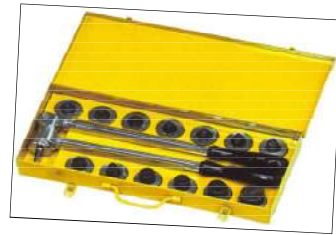

CODICE CODE	MODELLO MODEL	DESCRIZIONE DESCRIPTION	LISTINO PRICE LIST Euro
703064	WE01	pinza allargatubo a leva senza testina / tube expander tool without head	314,70
703086	WE02	valigetta metallica / iron carrying case	151,10
703066	WE08	testina per allargatubo / head for tube expander per diametri / for OD tubing 8mm	103,60
703068	WE10	testina per allargatubo / head for tube expander per diametri / for OD tubing 10mm	100,40
703070	WE12	testina per allargatubo / head for tube expander per diametri / for OD tubing 12mm	103,60
703072	WE14	testina per allargatubo / head for tube expander per diametri / for OD tubing 14mm	103,60
703074	WE16	testina per allargatubo / head for tube expander per diametri / for OD tubing 16mm	103,60
703076	WE18	testina per allargatubo / head for tube expander per diametri / for OD tubing 18mm	103,60
703078	WE22	testina per allargatubo / head for tube expander per diametri / for OD tubing 22mm	103,60
703080	WE28	testina per allargatubo / head for tube expander per diametri / for OD tubing 28mm	103,60
703082	WE35	testina per allargatubo / head for tube expander per diametri / for OD tubing 35mm	222,50
703084	WE42	testina per allargatubo / head for tube expander per diametri / for OD tubing 42mm	222,50
703069	WE 3/8	testina per allargatubo / head for tube expander per diametri / for OD tubing 3/8"	112,40
703071	WE 1/2	testina per allargatubo / head for tube expander per diametri / for OD tubing 1/2"	112,40
703073	WE 5/8	testina per allargatubo / head for tube expander per diametri / for OD tubing 5/8"	112,40
703075	WE 3/4	testina per allargatubo / head for tube expander per diametri / for OD tubing 3/4"	112,40
703077	WE 7/8	testina per allargatubo / head for tube expander per diametri / for OD tubing 7/8"	112,40

ALLARGATUBI IDRAULICO / TUBE EXTENDERS

703528	HE-mm.	allargatubi idraulico HE 10-12-16-18-22-28 MM.	850,00
703528	HE- inch	allargatubi idraulico HE 1/4-3/8-1/2-5/8-3/4-7/8-1-1/8"	850,00



HEAM
Allargatubi idraulico Robinair
Sbavutubi, valigetta rigida e 6 testine in millimetri
(10 - 12 - 16 - 18 - 22 e 28)

PIEGATUBI / TUBE BENDERS

703059	250	piegatubi a cricchetto / ratchet tube bender x diam. / for OD tubing 10-12-14-16-18-22	524,50
703059	260	piegatubi a cricchetto / ratchet tube bender x diam. / for OD tubing 3/8-1/2-5/8-3/4-7/8	524,50
703026	TB-364-04	curvatubo a leva / double handle tube bender diametri - OD tubing 6mm	53,30
703028	TB-364-8mm	curvatubo a leva / double handle tube bender diametri - OD tubing 8mm	53,80
703030	TB-364-10mm	curvatubo a leva / double handle tube bender diametri - OD tubing 10mm	74,10
703032	TB-364-08	curvatubo a leva / double handle tube bender diametri - OD tubing 12mm	89,50
703036	TB-364-16mm	curvatubo a leva / double handle tube bender diametri - OD tubing 16mm	121,10
703038	TB-364-12	curvatubo a leva / double handle tube bender diametri - OD tubing 19mm	153,60
703039	TB-364-14	curvatubo a leva / double handle tube bender diametri - OD tubing 22mm	194,00
703019	Molla 3/8"	molla curvatubo / spring tube bender 3/8"	38,50
703021	Molla 1/2"	molla curvatubo / spring tube bender 1/2"	38,50
703023	Molla 5/8"	molla curvatubo / spring tube bender 5/8"	42,80
703025	Molla 3/4"	molla curvatubo / spring tube bender 3/4"	42,80

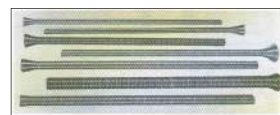

CHIAVI A CRICCO / RATCHET WRENCHES



703042	R6950M	chiave a cricco Belzer / Belzer ratchet wrench 1/4" - 5/16" - 8,5 - 9,5 - 13mm	161,50
703044	127C	chiave a cricco / ratchet wrench 1/4" - 3/8" - 3/16" - 5/16"	35,10

SALDATURA

WELDING

SET DI SALDATURA / WELDING RACKS



CODICE **MODELLO** **DESCRIZIONE**
CODE *MODEL* *DESCRIPTION*

LISTINO
PRICE LIST
Euro

con bombole ossi-propano / with oxy-propane cylinders

703310 80P/B kit bombole e telaio / bottles and frame kit 5,0 lt. 616,00
703311 80P/R kit riduttore, tubi, lancia e impugnatura / pressure regulator, hoses, lance, handle kit 820,20

con bombole ossi-acetilene / with oxy-acetylene cylinders

703312 80A/B kit bombole e telaio / bottles and frame kit 5,0 lt. 1.466,80
703313 80A/R kit riduttore, tubi, lancia e impugnatura / pressure regulator, hoses, lance, handle kit 962,60

SET DI SALDATURA PORTATILI / PORTABLE WELDING RACKS

TURBOSET

703300 TURBOSET 90 set di saldatura autogena / complete kit for autogen welding
703302 Oxigen110 cartuccia di ossigeno 110bar / oxygen cartridge 110bar
703304 Maxigas cartuccia di maxigas / maxigas cartridge



279,00
43,20
25,90

703343 SPITFIRE-PRO set di saldatura / WELDING RACK
703342 MAPP-PRO CARTUCCIA MAPP GAS / mapp gas cartridge

SPITFIRE-PRO



211,10
46,60

LEGHE SALDANTI, DISSOLIDANTI E SIGILLANTI / BRAZING ALLOYS, SEALERS AND FLUXES

CODICE **MODELLO** **DESCRIZIONE**
CODE *MODEL* *DESCRIPTION*

703314 1-RA-RA 1KG RAME-FOSFORO / 1KG COPPER-PHOSPHORUS 56,30
703315 1-RA-5% 1KG RAME-ARGENTO 5% / 1KG COPPER-SILVER 5% 186,10
703321 TOP-TEC-3 250G TOP-TEC3 32% / 250G TOP-TEC3 - 32% 226,00
703323 TOP-TEC-3-R 250G TOP-TEC3 RIC.32% / 250G TOP-TEC3 - 32% COATED 187,20
LECALLUMINIO TOP-TEC-ACU40 TOP-TEC-ALCU-40 - / ALUMINIUM ALLOY WELD 36,90

**** quotazioni leghe soggette ad adeguamento costo materia prima: chiedere conferma all'ordine**

703320 500-DISOX 500G DISSOLIDANTE / 500G FLUX POWDER 47,00
703322 HST SIGILLANTE EPOSSIDICO / EPOXY SEALER 84,10
CARLYCOOL DISSIPATORE DI CALORE VAPORIZZ. 600 ml. 39,70
703324 14225 SPECCHIETTO DA ISPEZIONE / INSPECTION MIRROR 23,80



RICAMBI / SPARE PARTS

703326 220500 riduttore per ossigeno turbo set / turbo set oxygen regulator 56,90
703327 201500 riduttore per propano turbo set / turbo set propane regulator 43,70

STRUMENTAZIONE
INSTRUMENTS

CERCAFUGHE ELETTRONICI / ELECTRONIC LEAK DETECTOR

CODICE CODE	MODELLO MODEL	DESCRIZIONE DESCRIPTION
703089	TIF XP1A	adatto per tutti i refrigeranti / suitable for all refrigerants
703087	TIF XP2	sensore di ricambio / replacement sensor



LISTINO PRICE LIST
€uro
599,00
52,50

703105	DISCOVERY	cercafughe a SENSORE RISCALDATO / refrigerants Leak detector
--------	-----------	---



688,75

CERCAFUGHE TRADIZIONALI / TRADITIONAL LEAK DETECTORS

703096	RPF400	cercafughe a schiuma / spray foam leak detector
--------	--------	---



28,00

CARLYLOC500		cercafughe a schiuma / spray foam leak detector
-------------	--	---



25,30

STRUMENTI DI MISURA / TEST INSTRUMENTS

CODICE CODE	MODELLO MODEL	DESCRIZIONE DESCRIPTION	LISTINO PRICE LIST
703218	DT10K	termometro digitale tascabile / pocket digital thermometer -40/+150°C	127,00
703220	PDT300/1C	termometro digitale tascabile a penna / pen pocket digital thermometer -40/+150°C	60,00
703233	DM5AK	multimetro digitale tascabile / pocket digital multimeter	119,50
703232	DL45	multimetro digitale a pinza / digital clamp-on meter	316,00
703229	DSM100	fonometro digitale / digital sound level meter 35/135dB	991,00



DT10K



PDT300/1C



DM5AK



DL45



DSM100



STRUMENTAZIONE

INSTRUMENTS

STRUMENTI DI MISURA / TEST INSTRUMENTS

CODICE **MODELLO** **DESCRIZIONE**
CODE **MODEL** **DESCRIPTION**



SIR50B



DT20/1



LISTINO
PRICE LIST
€uro

703224 DT20/1 termometro digitale / digital thermometer -40/+150°C
 703241 SIR-50B termometro a infrarossi / infrared thermometer -50/+510°C
 703243 STH950 termoigrometro digitale / digital thermoigrometer 0/+50°C 25/95% RH

351,00
 610,00
 113,40

REGISTRATORI GRAFICI DI TEMPERATURA / TEMPERATURE RECORDER



703501 RTA/1-160 REGISTRATORE GRAFICO SETTIMANALE INOX DIAMETRO 160
 INOX DIAM. 160 TEMPERATURE RECORDER
 703510 RTW pennino per registratore di temperatura / pen for temperat. recorder
 703512 DGM diagramma per registratore grafico / paper for temperature recorder

765,00
 36,80
 2,00

123568 PLUS EXPERT DL3 registrat. a 3 canali con possibilità di visualizzare direttamente
 con scarico dati tramite porta USB
 123569 PLUS EXPERT DL8 registrat. a 8 canali con possibilità di visualizzare direttamente
 con scarico dati tramite porta USB
 3 OR 8 channels temp.recorder wich allows recorded temperatures
 to be displayed directly on the screen,or recorded on USB PORT



550,30
 687,60

TERMOMETRI / THERMOMETERS

703214 DTE termometro digitale da pannello / panel digital thermometer -40/+50°C
 703215 DTBOX box di fissaggio per DTE / mounting box for DTE
 703208 THG5050 termometro a gabbia / cage thermometer -50/+50°C
 703212 TE4040 termometro a gancio / hang-on thermometer -40/+40°C
 703213 TM4040 termometro a gancio in Moplen / Moplen hang-on thermometer -40/+40°C
 703210 FG80K termometro analogico / analogic thermometer -40/+27°C
 703200 F87R60 termometro a flangia reversibile / reversible flange thermometer -40/+40°C d.60mm
 703202 F87R80 termometro a flangia reversibile / reversible flange thermometer -40/+40°C d.80mm
 703204 F87R100 termometro a flangia reversibile / reversible flange thermometer -40/+40°C d.100mm
 703206 ROF88 termometro a clips / clips thermometer -40/+40°C
 122501 CPNF termometro a clips / clips thermometer -40/+40°C
 122511 TT-C DIGIT termostato digitale / digital thermostat -35/+35°C

33,00
 7,00
 30,00
 6,00
 8,00
 20,00
 36,00
 40,00
 44,00
 19,00
 19,60
 58,00



DTE

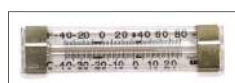

FG80K



ROF88



THG5050



TE4040



TM4040



CPNF



F87R...

TT-C
 DIGIT



STRUMENTAZIONE DIGITALE DI VUOTO

VACUUM DIGITAL INSTRUMENTS

GRUPPO MANOMETRICO DIGITALE FOX 100 / FOX 100 DIGITAL MANIFOLD



scala di pressione/ pressure Range in: bar-psi-Mpa
 scala temperatura in:/temperature range in: °C/°F
 refrigeranti preinstallati / pre-loaded refrigerants 55
 calcolo del sottoraffredd. e surriscald. / superheat and subcooling calculation

CODICE **MODELLO** **DESCRIZIONE**
 CODE MODEL DESCRIPTION

LISTINO
 PRICE LIST
 €uro

703301 **FOX100** **kit gruppo manometrico elettronico digitale / recording digital gauge set completo di valigetta e sonde standard / with case and std probes adatto per tutti i refrigeranti / suitable for all refrigerants**

553,80



GRUPPO MANOMETRICO DIGITALE KIMO / KIMO DIGITAL MANIFOLD

Prezzo Netto

KIMO-MANIFOLD	Si RM3	kit gruppo manometrico elettronico digitale / recording digital gauge set	216,00
KIMO-VACUUM	Si Rv3	vacuometro digitale / digital vacuum gauge	140,00

PRODOTTI CHIMICI

CHEMICAL PRODUCTS

CODICE **MODELLO** **DESCRIZIONE**
 CODE MODEL DESCRIPTION

LISTINO
 PRICE LIST
 €uro

PRODOTTI CHIMICI / CHEMICAL PRODUCTS

704019	Trace-21004	liquido tracciante da 118cc / tracer fluid package 118cc	40,90
704021	Thawzone-17004	liquido disidratante da 118cc / dehydrating fluid package 118cc	35,30
704018	Leak-Lock-10001	sigillante per raccordi filettati da 40cc / thread sealers pack. 40cc	20,60
704020	Thermal Mastic	tubetto pasta conduttrice da 220gr / heat transfer 220gr	38,50
704009	FO-200	olio universale per cartelle 200ml / universal oil for flare 200ml	13,10

CARLYCOOL **DISSIPATORE DI CALORE IN VAPORIZZATORE 600 ML.** **39,70**

TEST PER OLIO / OILS TESTER

TESTOILPOE	TEST ACIDITA' OLIO POE / POE OIL ACID CHECKER
DETECTOILPOE	IDENTIFICATORE DI OLIO POE / POE OIL IDENTIFIER



25,20

56,20



Trace



Thawzone

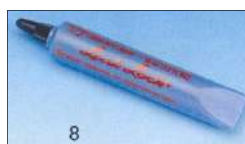

Leaklock



FO-200

GAS REFRIGERANTI

REFRIGERANTS

CODICE CODE	MODELLO MODEL	DESCRIZIONE DESCRIPTION	LISTINO PRICE LIST
----------------	------------------	----------------------------	-----------------------

GAS REFRIGERANTI / REFRIGERANTS

704023	R407C	gas refrigerante / refrigerant R407C (SUVA 9000)	
704025	R410A	gas refrigerante / refrigerant R410A (SUVA 9100)	
704028	R134a	gas refrigerante / refrigerant R134a (SUVA 134a)	
704030	R404A	gas refrigerante / refrigerant R404A (SUVA HP62)	

MISCELE / BLENDS

704029	R422D	gas refrigerante / refrigerant R422D (ISCEON MO29)	
704054	R407F	gas refrigerante / refrigerant R407F (SOST. R404A)	
704061	R448A	gas refrigerante / refrigerant R448A (SOST. R404A)	
704063	R449A	gas refrigerante / refrigerant R449A (SOST. R404A)	
704064	R452A	gas refrigerante / refrigerant R452A (SOST. R404A)	

BOMBOLE COMPLETE DI CARICA GAS REFRIGERANTE

SAP134	R134A	bombola / disposable bottle with refrigerant 10 KG	
SAP404	R404A	bombola / disposable bottle with refrigerant 10 KG	
SAP407	R407C	bombola / disposable bottle with refrigerant 10 KG	
SAP410	R410A	bombola / disposable bottle with refrigerant 10 KG	

SAP5-R134	R134A	bombola / disposable bottle with refrigerant 5 KG	
SAP5-R404	R404A	bombola / disposable bottle with refrigerant 5 KG	
SAP5-R407	R407C	bombola / disposable bottle with refrigerant 5 KG	
SAP5-R410	R410A	bombola / disposable bottle with refrigerant 5 KG	

704047	R134A	bombola / disposable bottle with refrigerant 900 gr.	
704049	R407C	bombola / disposable bottle with refrigerant 850 gr.	
704050	R410A	bombola / disposable bottle with refrigerant 800 gr.	
704058	R32	bombola / disposable bottle with refrigerant 0800 gr.	
704052	R600	bombola / disposable bottle with refrigerant 1000 gr.	
704045	R290	bombola / disposable bottle with refrigerant 0370 gr.	
704048	R404A	bombola / disposable bottle with refrigerant 0790 gr.	

ACCESSORI / ACCESSORIES

704040	BOMBOLA 40KG	bombola vuota doppio rubinetto / tank empty 2 valves 40kg	360,00
704042	BOMBOLA 12KG	bombola vuota singolo rubinetto / tank empty 1 valve 12kg	225,00
704042W	BOMBOLA 12KG	bombola vuota doppio rubinetto 44 bar /44 bar tank empty 2 valve 12kg	236,40
RIDUGAS	RIDUZ.-BOMBOLA	riduzione per bombola / reducing fitting for bottles 1/4" o 5/16"SAE	11,00



704055	RSF400/2T	resistenza a fascia 400 w. / 400 w.heater	187,00
--------	-----------	---	--------



* quotazioni a richiesta / prices on request

LUBRIFICANTI

LUBRICANTS

CODICE CODE	MODELLO MODEL	DESCRIZIONE DESCRIPTION	LISTINO PRICE LIST
LUBRIFICANTI YETI POE / YETI POE LUBRICANTS			
YETI-POE32-20	OLIO POE 32	confezione da 20 lt. / 20 lt. package	571,10
YETI-POE46-20	OLIO POE 46	confezione da 20 lt. / 20 lt. package	599,40
YETI-POE68-20	OLIO POE 68	confezione da 20 lt. / 20 lt. package	587,10
YETI-POE100-20	OLIO POE 100	confezione da 20 lt. / 20 lt. package	640,40
YETI-POE32-05	OLIO POE 32	confezione da 5 lt. / 5 lt. package	151,40
YETI-POE46-05	OLIO POE 46	confezione da 5 lt. / 5 lt. package	158,10
YETI-POE68-05	OLIO POE 68	confezione da 5 lt. / 5 lt. package	155,30
YETI-POE100-05	OLIO POE 100	confezione da 5 lt. / 5 lt. package	168,70



LUBRIFICANTI / LUBRICANTS

olio poliestere POE / Polyester POE oil

704012	POE-OIL-ACD 32	confezione da 5 lt. / 5 lt. package	255,90
704014	POE-OIL-68	confezione da 5 lt. / 5 lt. package	255,90
704016	POE-OIL-01	confezione da 1 lt. / 1 lt. package	67,50
704017	POE-OIL-20	confezione da 20 lt. / 20 lt. package	846,90



olio alchilbenzenico / alchilbenzenic oil

704008	ALCHIL-OIL	confezione da 20 lt. / 20 lt. package	590,70
--------	------------	---------------------------------------	--------

olio minerale Suniso / Suniso mineral oil

704000	2935-4 (3G)	confezione da 3,78 lt. / 3,78 lt. package	81,60
704002	2935-20 (3G)	confezione da 18 lt. / 18 lt. package	346,60
704004	6174-4 (4G)	confezione da 3,78 lt. / 3,78 lt. package	81,60
704006	6174-20 (4G)	confezione da 20 lt. / 20 lt. package	346,60



DOCUMENTAZIONE TECNICA

TECHNICAL BOOKS

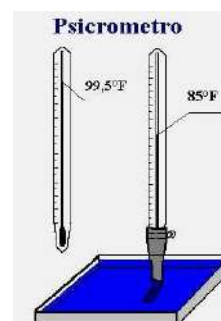

	LISTINO PRICE LIST €uro
MANUALE PER PICCOLI IMPIANTI DI CLIMATIZZAZIONE - prezzo netto iva compresa	78,00
L'ARTE DEL FREDDO - prezzo netto iva compresa	172,00
	pg. 75

CONDIZIONI GENERALI DI VENDITA

A OFFERTE ED ORDINI

Gli ordini non impegnano la nostra società se non preventivamente accettati per iscritto e restituiti al cliente.-

B RESA

La resa della merce venduta si intende FRANCO I NOSTRI MAGAZZINI, le quotazioni NON comprendono perciò spese di trasporto ed accessorie; la merce viaggia, in ogni caso a rischio e pericolo dell'acquirente, anche quando per speciale pattuizione la resa sia convenuta franco destino.-

C TERMINI DI CONSEGNA

I termini di consegna sono indicativi, salvo il venduto e non impegnano la nostra società se non previa specifica pattuizione da noi controfirmata e comunque eventuali ritardi non danno diritto ad alcun risarcimento né ad alcun addebito.-

D IMBALLI

Se non espressamente specificato, gli imballi si intendono addebitati al costo.-

E CARATTERISTICHE DELLA MERCE

Eventuali modifiche non sostanziali che dovessero essere introdotte in qualsiasi momento nei prodotti da noi commercializzati, anche da parte dei nostri fornitori, per motivi di miglioramento e/o di convenienza non possono dare luogo a contestazioni da parte del committente.-

F PREZZI

I prezzi del listino sono soggetti a variazioni senza obbligo specifico da parte nostra di dare preavviso alcuno; i prodotti di importazione sono soggetti a variazione cambio.-

G PAGAMENTO

Salvo accordi diversi il pagamento si intende per contanti alla consegna.-

H INTERESSI

Sui ritardati pagamenti decorrono interessi di mora pari al Prime Rate aumentato di 5 punti.-

I RISERVA DI PROPRIETA'

Le vendite con pagamento differito si intendono eseguite con riserva di proprietà fino al totale pagamento.-

L RECLAMI

Non si accettano reclami se non pervenuti entro 8gg dalla data di spedizione a mezzo lettera raccomandata; decorso tale termine la merce si intende regolarmente accettata.-

M GARANZIA

I prodotti da noi commercializzati sono garantiti da ogni difetto costruttivo per un anno dalla data di consegna; la garanzia si intende prestata presso e franco i nostri magazzini e riguarda esclusivamente l'obbligo di riparare e/o sostituire quei particolari che per la qualità dei materiali e/o per vizi di costruzione si manifestassero difettosi :

i materiali inoltratici per garanzia devono pervenirci in porto franco ed esclusivamente successivamente a nostra autorizzazione scritta.-

Per le apparecchiature elettriche valgono le norme di garanzia della ANIE;

La garanzia non è valida in caso di interventi e/o manomissioni effettuate da personale estraneo alla nostra organizzazione.-

N FORO COMPETENTE

Per ogni controversia cui potesse dare luogo la fornitura sarà competente il foro di Milano

IL LISTINO PREZZI E' VALIDO SU TUTTO IL TERRITORIO NAZIONALE, ANNULLA E SOSTITUISCE OGNI PRECEDENTE E PUO' ESSERE VARIATO SENZA ALCUN PREAVVISO